

01/2022

VMA VERLAG  
Cologne /Germany



# EXTRUSION INTERNATIONAL

USA

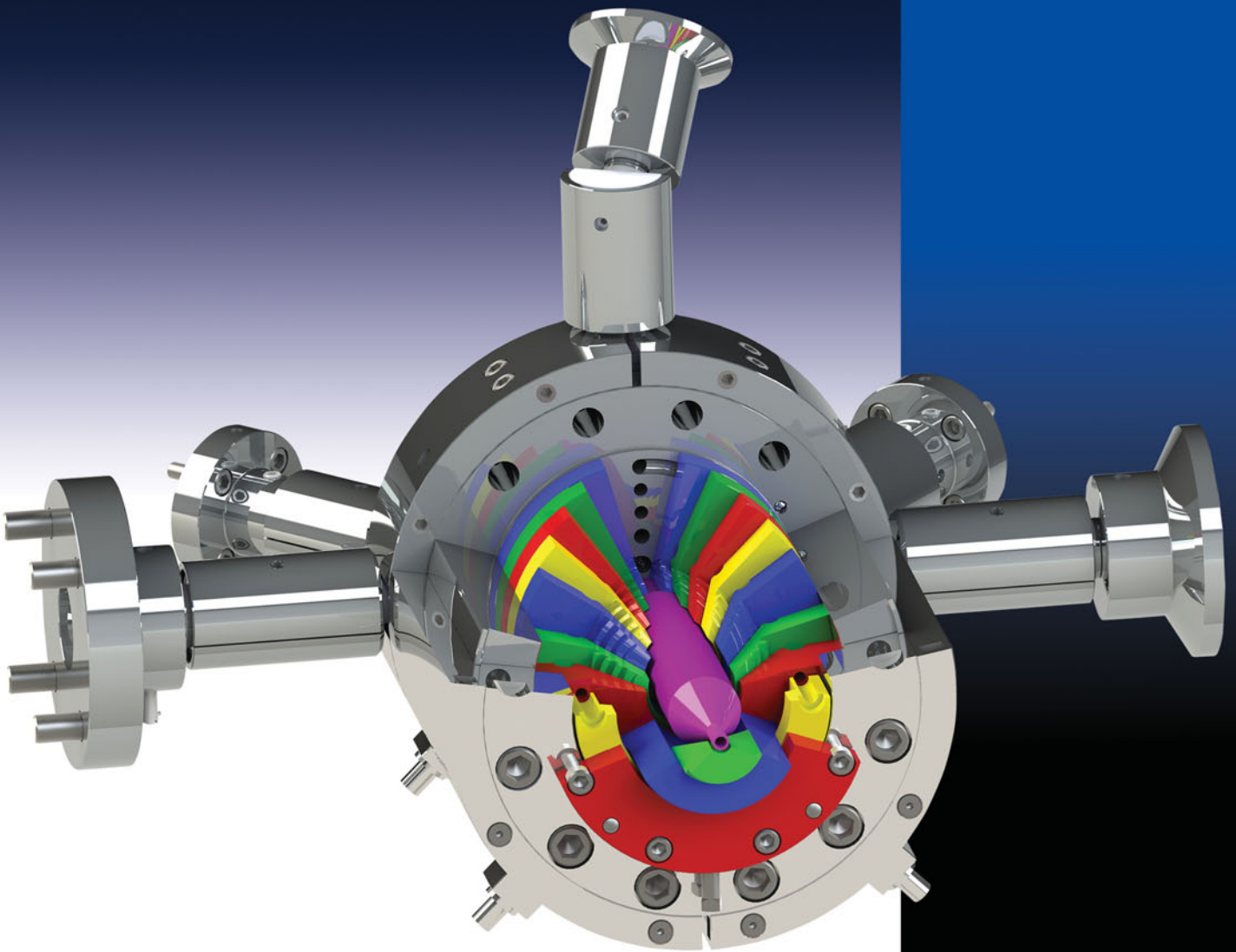

6 Layer Tubing Die

**Guill**  
EXTRUSION TOOLING

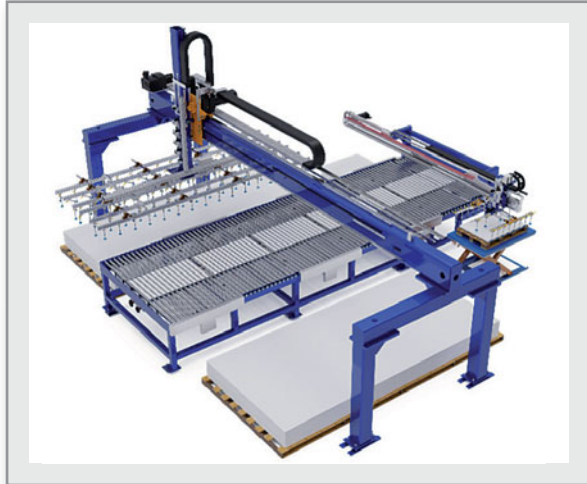

### Plate Stacking Machine

for automatic depositing of your production plates on transport pallets or trolleys.

Optional available with:

- Additional stacking places
- Spreading device of sheets side by side
- Separation of consecutive panels for simultaneous stacking

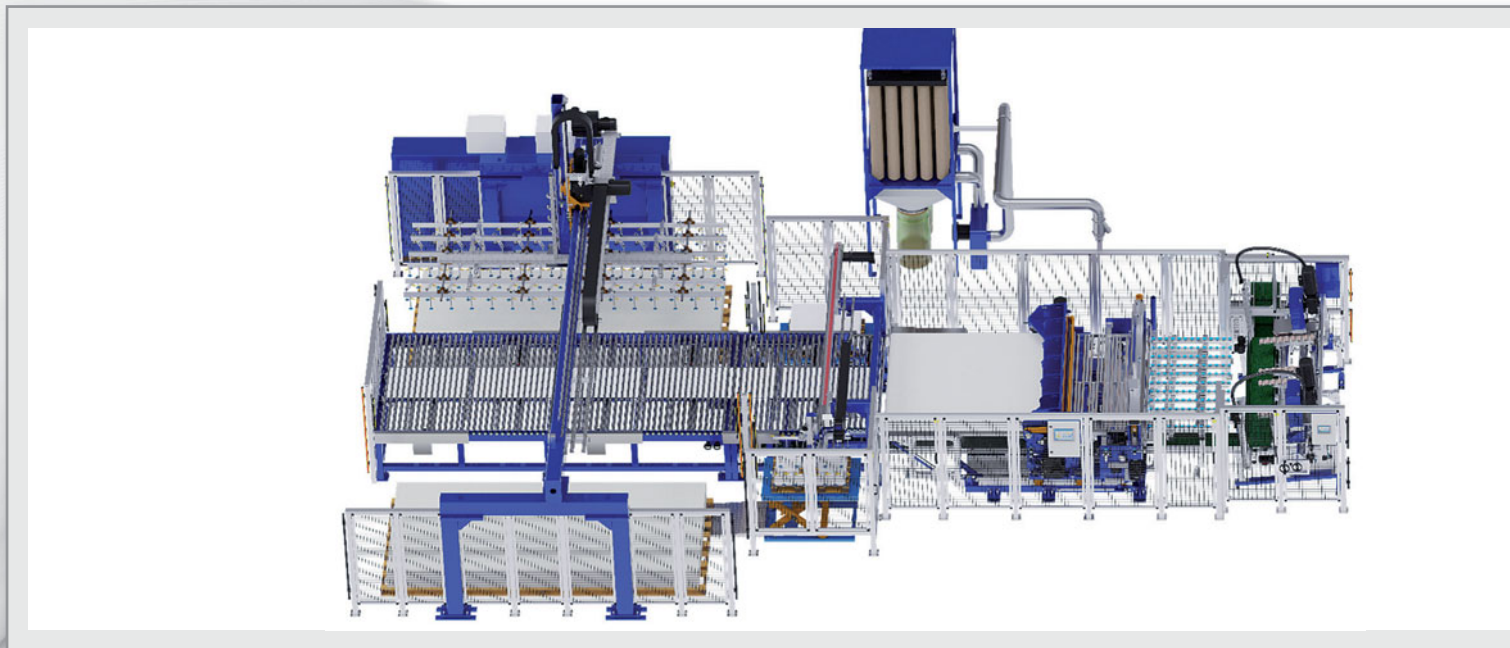

### Cross Cutting Combination

enables optional sawing or cutting in one machine.

Optional available with:

- Hydraulic driven scissor
- Electric driven scissor
- Cross Cut Mill instead of saw
- Cutting angle adjustment



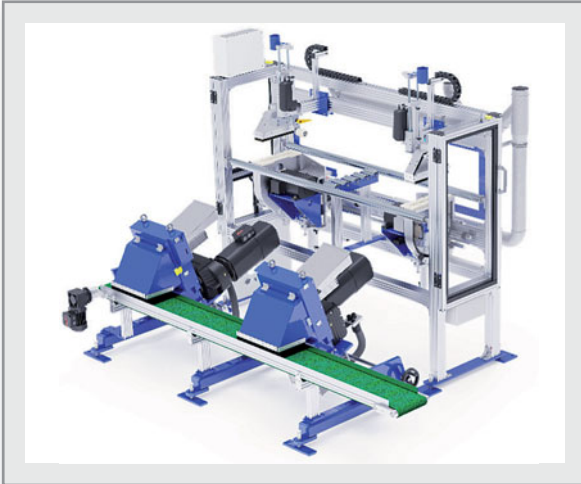

### Edge Trimming Saw & Trim Strip Chopper

an unbeatable team for longitudinal cutting of your panel and direct shredding of the resulting return material.

The machines are also offered individually with many options.

As a specialist in the field of special machine construction, we always find a solution!

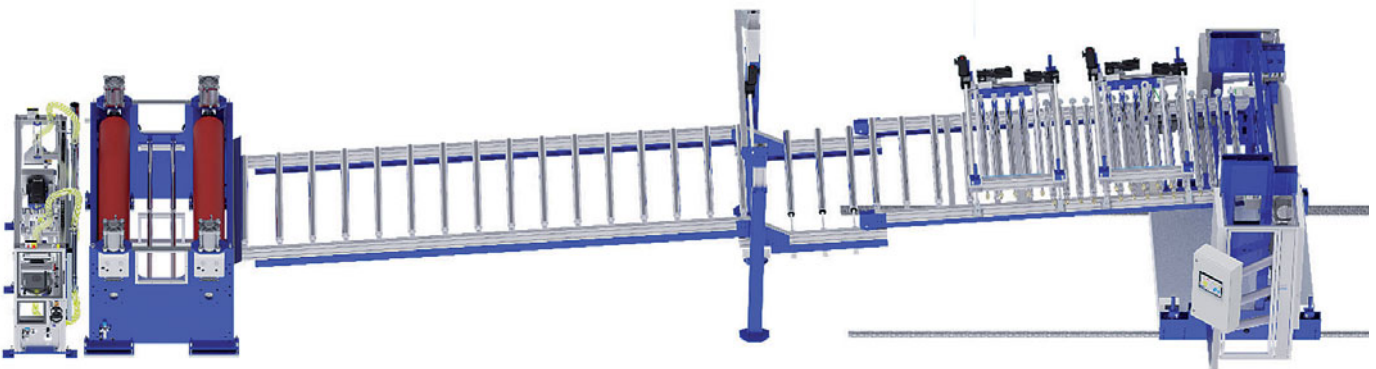

### Pull Off Roller

provides precise regulation and compliance of roller speed and roller force.

#### Optional available with:

- Automatic material run control
- Selection of roller coatings
- Multiple Pull Off Roller version

### Calender

for continuous dimensional accuracy and surface quality.

#### Key data:

- Throughput capacity depending on material 400 - 1300 kg/h
- Line speed 0,5 - 70 m/min
- Line pressure per roller: 100-1300 N/cm



### STEIN Maschinenbau GmbH & Co. KG

Wartbachstrasse 9  
66999 Hinterweidenthal/Germany  
Tel. (+49) (0)63 96-9215-0  
Fax (+49) (0)63 96-9215-25  
stein@stein-maschinenbau.de  
www.stein-maschinenbau.de

Firms in this issue	6	„Mixing Possible“ – The CMQ Container Mixer Sets	
Imprint	7	New Standards in Safety and Productivity	26
<b>Industry News</b>	8	Science Award 2020	27
Calendar	8	POWTECH 2022 – Change of Date	27
Measurement World 2022	8	<b>Industry News USA</b>	28
Monthly K-Talk Starts Online	8	The US Plastics Industry in 2021	28
Chinaplas 2022 – Indonesia Embarks on Smart Manufacturing for Sustainable Plastics Production	9	Line for Innovative Capacitor Films Installed	29
Interpack 2023	10	Appointment as Chief Operating Officer Announced	29
Record Numbers Attend Plastics Recycling Show Europe 2021	10	Multiuse XP Express® – AGT Roll Stand Introduced	30
„Laboratory & Quality Control in Plastics Processing“	12	New Chief Financial Officer Appointed	30
New Partnership	12	New President in the US Appointed	31
Polyamide Compound Manufacturing Reaches New Throughput Dimension	13	<b>Extrusion Tooling</b>	
Used Machinery Trading Cooperation for the Middle East Region Started	14	Design and Manufacture of Extrusion Tooling for Numerous Applications – and Uncompromising Service	32
Investment in the Development of R&D Center	14	<b>Recycling</b>	
Plastics and Rubber Processing Machines: Sector in Recovery	15	New Dimension with Large-Scale Recycling Plants	34
Acquisition	16	<b>Recycling – Case Study</b>	
Investments in Sustainable Film Solutions Expanded	16	Mixed Waste Sorting Changing the Game	36
MEWAR Award „Plastics Recycling Company of the Year 2021“	18	<b>Recycling</b>	
Record Year Reported	18	Recycling Company in United Kingdom Processes ASR Fractions and Electronic Scrap Using the Rotorshredder from Germany	40
Joint Venture in China Established	19	<b>Recycling – From the Research</b>	
Plant Engineering Expertise Expanded	20	Research Evaluates the Impact of Printing Inks on Recyclability of Plastics Films	42
Industrial Operation Started	20	<b>Recycling, Thermoforming</b>	
Efficient Powder Coating Manufacturing Using Twin Screw Extruders	21	New Recycling Options for Printed PP Films	44
Sales Team for Web Inspection Systems Expanded	21	<b>Polyester Recycling – Interview</b>	
From PET Bottles Straight to Food Contact Grade r-PET Packaging	22	How Spinning and Recycling Go Together	46
Sales Coverage in Germany Boosted	22	<b>Blown Film – Case Study</b>	
Strategic Partnership	23	Mission Circular Economy – High-performance full PE films through MDO technology	48
Market Study Polypropylene	23	<b>Material Handling</b>	
New Additive Solutions for Mechanical Recycling of Plastics	24	Preconfigured Feeders Offer Plastics Industry a Powerful and Efficient Feeding Solution	50
Five Time More Flakes from Recycled PET Bottles	24	<b>Extrusion Technology, Natural Fiber Composites</b>	
New Location	25	Extrusion Lines for Natural Fibre Waste Strengthened	52
Functions in Customer Portal Added	25	<b>Sheet Extrusion</b>	
		Cross-Linked Foam Boards Produced on ZE BluePower Extruder	54



**36** TOMRA and a Norwegian waste sorting plant have demonstrated that mixed waste sorting prior to disposal is a superior solution to separate collection. Since it stopped the separate collection for plastics in its region and unleashed the power of mixed waste sorting, the facility increased recovery rates from 28% to 82% and achieved recycling rates of 56,4%



**40** British recycling specialists Recycling Lives commissioned a recycling plant that was planned and implemented by BHS-Sonthofen. The plant is designed to handle a variety of materials such as automotive shredder residue (ASR), electric and electronic scrap (WEEE) as well as so-called "meatballs" (electric motors and motor armatures)

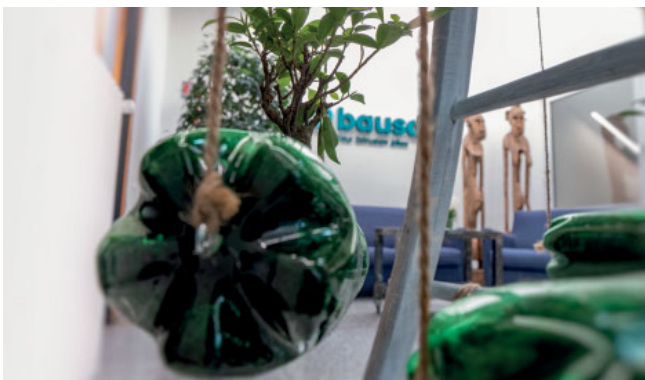

**52** Sustainability is now a key concept that affects all economic sectors, first and foremost construction. In this respect, Bausano responds to the new needs of the sector, enhancing its extrusion lines for plastic waste (PVC, PE or PP) and natural fibres residues



**44** The research initiative PrintCYC, of which KIEFFEL is a member, has gained further insights into promoting the circular economy of plastic packaging through material recycling

**50** Answering the call from the marketplace for a robust and reliable feeder for simple feeding applications in the plastics industry, Coperion K-Tron developed a completely new feeder line built on 100 years of feeding experience



With the further development of its proven MDO technology, Hosokawa Alpine has succeeded in taking a decisive step towards the production of sustainable packaging from blown film **48**



## Index of Advertisers, companies and *fairs* referred in this issue

<b>Adsale</b>				
AKK INNOVATION				31
AKRO-PLASTIC				54
AMUT				12
A Più				12
BASF				14
Bausano				8
BB Engineering				25
Beier				7
BHS-Sonthofen				29
Blow Molding & Caps				15
Borealis				21
Brückner				29
Ceresana				16
Chinaplas				28
Converting Russia				10
Coperion				27
Coperion K-Tron				11
Davis-Standard				23
EREMA				16
Fachpack 2022				14, 20
GINDUMAC				30
Gneuss				31, 38
Guill				13
Herbold Meckesheim				Inside Front Cover+3
Hosokawa Alpine				36
interpack 2023				18, 22
IPTF 2022				Inside Back Cover
k-online				20, 26
KIEFEL				27
	<b>9, Outside Back Cover</b>			
	42	KraussMaffei		
	19	KraussMaffei Extrusion		
	22	Laboratory & Quality Control		
	15	Logoplaste		
	24	MAPTEC		
	52	Measurement World 2022		
	46	Meraxis		
	17	motan-colortronic		
	40	Muller Technology Col.		
	43	Nanjing Lesun		
	23	OCS		
	42	Peak Nano Films		
	23	Piovan		
		PLASTICS		
	<b>9, Outside Back Cover</b>	Plastics Recycling Show		
	39	POWTECH 2022		
	<b>11, 13, 21</b>	Prorate		
	50	Reclay		
	29, 30	RKW		
	22, 25, 34	R&P Polyplastic		
	27	SI		
	14	Smart-Extrusion		
	18	Starlinger Group		
	<b>Outside Cover, 32</b>	Stein Maschinenbau		
	24	TOMRA		
	48	Vetaphone		
	10	VM Verlag		
	45	Zeppelin		
	8	ZwickRoell		
	44			



**Follow the news  
in the world  
of extrusion!**

Subscribe to digital magazines  
and Smart Extrusion weekly newsletter

- **Just** submit your **e-mail address**.
- Digital magazines and news updates **free of charge**
- No spam. Your data is safe



[www.extrusion-info.com/subscription](http://www.extrusion-info.com/subscription)



The Extrusion International Magazine is published bimonthly by VM Verlag GmbH. P.O.Box 501812, D- 50879 Cologne, Germany

**EDITORS**

Bettina Jopp-Witt (Editor-in-chief)  
Tel. +49 221 546 1539  
redaktion@vm-verlag.com

Dmitry Kosuch  
Tel. +7 996 730 0113  
d.kosuch@vm-verlag.com

**ADVERTISING SALES**

Martina Lerner  
Tel.+49 6226 971515  
lerner-media@t-online.de

Bella Eidlin  
Tel. +49 152 29907895  
b.eidlin@vm-verlag.com

Olga Kirchner  
Tel. +49 152 05626122  
o.kirchner@vm-verlag.com

**ADMINISTRATION**

Alla Kravets  
Tel. +49 2233 949 8793  
a.kravets@vm-verlag.com

**PRINTING**

maincontor GmbH  
Dr.-Gammert-Str. 13a, 63906 Erlenbach, Germany  
T.: +49 937294810811  
www.maincontor.de, info@frankhohmann.com

**SALES REPRESENTATIVES**

Quaini Pubblicita (Milano IT)  
Tel. +39 02 39216180  
info@quaini-pubblicita.it

China & Asia  
octavia@ringier.com.hk, Tel. +852-9648-2561  
maggeliu@ringiertrade.com, Tel. +86-13602785446

Tokyo PR Inc. (Japan)  
Tel. +81 (3) 3273-2731  
extrusion@tokyopr.co.jp

**Reprints, Translation etc**

No part of this publication may be reproduced, stored in a retrieval system, or transmitted, in any form or by any means, electronic, mechanical, photographic, recording or otherwise, without prior permission of the publisher.



[www.smart-extrusion.com](http://www.smart-extrusion.com)

**One of the most flexible  
hopper loaders on the market**

 think materials management



**METRO G/F**

Whether granules or flakes, the METRO G/F enables large conveying volumes and is also suitable for dusty material thanks to the implosion cleaning of the sieve filters.

motan-colortronic gmbh - info@motan-colortronic.de  
[www.motan-colortronic.com](http://www.motan-colortronic.com)



#### bio!PAC

15. - 16. 03. 2022  
Düsseldorf, Germany (Hybrid)  
[www.bio-pac.info](http://www.bio-pac.info)

#### Blow Molding & Caps

15. 03. 2022  
Moscow, Russia  
[blow-molding.extrusion-info.com](http://blow-molding.extrusion-info.com)

#### ICE Europe

15. - 17. 03. 2022  
Munich, Germany  
[www.ice-x.com/europe](http://www.ice-x.com/europe)

#### 12th European Thermoforming Conference

31. 03. - 01. 04. 2022  
Vienna, Austria  
[www.thermoforming-europe.org](http://www.thermoforming-europe.org)

#### Plastasia 2022

20. - 23. April 2022  
New Delhi, India

#### CHINAPLAS 2022

25. - 28. 04. 2022  
Shanghai, P.R. China  
[www.ChinaplasOnline.com](http://www.ChinaplasOnline.com)

#### IPTF 2022

17. - 18. 05. 2022  
Saint Petersburg, Russia  
[www.iprf.extrusion-info.com](http://www.iprf.extrusion-info.com)

#### Measurement World 2022

17. - 20. 05. 2022  
Paris / France  
[www.global-industrie.com](http://www.global-industrie.com)

#### COLOMBIAPLAST

26. - 30. 09. 2022  
Bogotá, Colombia  
[www.eng.colombiaplast.org](http://www.eng.colombiaplast.org)

#### wire South America

**TUBOTECH**  
25. - 27. 10. 2022  
[www.wire-south-america.com](http://www.wire-south-america.com)  
[www.tubotech-online.com](http://www.tubotech-online.com)

#### INDIA ESSEN WELDING & CUTTING 2021

23. - 25. 11. 2022  
Bombay, India  
[www.india-essen-welding-cutting.com](http://www.india-essen-welding-cutting.com)

## Measurement World 2022

May 17–20, 2022, Paris Nord–Villepinte

■ In 2022, Measurement World – the international event for players in the measurement industry (analysis/control/optics/process/vision) – will add to the measurement players typically represented at Global Industrie. Exclusive content will be proposed in addition to this specialised offering, including the International GAS Analysis 2022 Symposium.

The exceptional situation in 2021 has significantly changed the events landscape and given rise to unique associations. Indeed, the joint holding of Global Industrie and Measurement World 2021 in Lyon, has demonstrated the relevance of creating synergies between the measurement sector and that of industrial development. This mutually beneficial initiative was welcomed positively by the participants (exhibitors, visitors, attendees, partners) who were keen to perpetuate and amplify this approach.

Driven by this enthusiasm, in 2022, Measurement World becomes an integral part of Global Industrie in Paris. This broadened horizon brings together industrial users, experts, academics, manufacturers, contractors, international and institutional laboratories, and promotes French and European technological know-how, related in particular to instrumentation, metrology and analysis. Also, as a springboard to launch innovations and a monitoring tool for the sector, it offers a unique opportunity to see, touch and understand the scope of the technological solutions and contributions of measurement (control, optimisation, productivity, quality, reliability, effective use of data...) dedicated to the different industry sectors.

The exhibition's format combining exhibitions, demonstrations, business meetings, expert content, also hosting a scientific congress, make it an appealing common focal point for industry and research.

For this edition, the CFM (Collège Français de Métrologie) will organise le Symposium international GAS Analysis 2022.

In parallel, a 4-day programme of technical conferences open to all will be presented by EMVA (European Machine Vision Association), LCIE BUREAU VERITAS and the CFM (Collège Français de Métrologie).

► [www.global-industrie.com](http://www.global-industrie.com)

## Monthly K-Talk Starts Online



■ On October 19 this year, K 2022 will open its doors for eight days. For the 22nd time, K in Düsseldorf will be the performance barometer for the entire industry and its global marketplace for innovations.

K 2022 already offers a real highlight to get you in the mood for the major industry event: the new K-Talk. For the first time on January 20 and then once a month until the trade show in the fall, the K-Talk offers exciting discussion rounds with changing international participants, such as industry experts, scientists, representatives of the user industries, from politics, media or NGOs. In doing so, K-Talk provides valuable insights, focuses on the application areas of plastics, highlights technological innovations and discusses current challenges of the industry such as circular economy, climate protection and digitalization. Whether concrete best practice examples or long-term strategies for the future – the visions and different perspectives of the panelists are intended to inspire, provide orientation and encourage international exchange.

The K-Talk will be broadcast live via [k-online.com](http://k-online.com) and will each last 45 to a maximum of 60 minutes. The international format is in English. Active exchange is encouraged, so questions can be submitted throughout the talk via the chat function. The last quarter of an hour of K-Talk is then devoted exclusively to answering questions from the audience.

► [www.k-online.de](http://www.k-online.de)



## Chinaplas 2022 – Indonesia Embarks on Smart Manufacturing for Sustainable Plastics Production

■ Southeast Asia's largest economy, Indonesia, has a fast-growing plastics industry owing to robust demand from its food & beverage (F&B) packaging sector that accounts for around 60% of the plastics industry's output. The country's huge population of more than 270 million presents an attractive market for F&B packaging. But Indonesia continues to face mounting plastic waste problems that collaboration between the government and private organizations are directed towards programs and projects for an effective waste management system and recycling in order to implement a circular economy.

Indonesia generates about 6.8 million tons of plastic waste every year, according to the Indonesia National Plastic Action Partnership (NPAP), a collaboration between the Ministry of Maritime Affairs and Investment and the Global Plastic Action Partnership. Roughly 80% of the plastic waste comes from land while the remaining 20% comes from coasts and oceans. The country announced a new plan during the World Economic Forum's Annual Meeting in Davos in 2021, where it pledged to reduce marine plastic waste by 70% within five years and to become totally pollution-free by 2040. The plan also calls for redesigning of plastic products for recycling and eventual reuse, with the objective to double the recycling capacity in order to be able to process an additional of 975,000 tons of waste annually. Indonesia is also building and expanding its waste disposal facilities to manage an additional of 3.3 million tons of plastic waste yearly.

The packaging industry is witnessing the fastest growth among the various plastics-dependent industries in Indonesia in terms of adherence to the smart manufacturing concept. This sector is projected to grow from 141.3 billion units in 2019 to 159.2 million units in 2024, registering a CAGR of 2.4%, according to a study by Reportlinker, which also states that flexible packaging is expected to witness the fastest CAGR during 2019 to 2024 among other packaging types.

Aside from ensuring flexibility and improving profitability, smart packaging is now being embraced in many products – such as in foods and beverage, pharmaceuticals, etc. – to provide crucial information on product quality, ex-



tend shelf life, trace movement of the product in the supply chain, and for safety and protection. Indonesian plastics packaging manufacturers are becoming more aware that the only way to go is by implementing smart manufacturing through digitalization. Real-time production information plus product traceability are benefits that smart manufacturing offers which Indonesian companies are now serious taking into consideration in order to stay competitive.

As some leading F&B companies in Indonesia have been following the Industry 4.0 trends, they also see the importance of digitalization to meet their sustainability goals as they intensify their recycling to alleviate plastic packaging waste, especially single-use plastics. Members of the Packaging and Recycling Association for Indonesia's Sustainable Environment (PRAISE) which established the Packaging Recovery Organization (PRO) have identified methods from waste collection to recycling. PRAISE members include PT Coca-Cola Indonesia, Danone-Aqua, PT Indofood Sukses Makmur,

In the area of smart packaging, even foreign companies are setting their sights into Indonesia's vast market due to its large population. Baoshen Science & Applied Technologies Co., Ltd (BSN), a leading Chinese company that produces packaging materials for garment products (shoes, clothes and bags), furniture products, cosmetics, etc., has set up an operation at Indonesia's Kendal Industrial Park. The construction of the factory started in August 2021 and is expected to be operational in June 2022. Since its founding in 1988, BSN has succeeded in becoming a "smart packaging" industry by establishing a Technology Center for RFID-based label design and production.

Southeast Asian countries, like Indonesia, present opportunities for companies offering high-tech solutions for packaging production. With digitalization and smart manufacturing becoming the trends of the future for the packaging sector, CHINAPLAS 2022 brings under one roof the best solutions that manufacturers from Southeast Asia and from other parts of the world can utilize to boost their productivity and strengthen their competitiveness.

*Indonesia is a major potential market for smart manufacturing technologies  
(Photo: Tom Fisk/Pexels)*



## Interpack 2023

■ The advisory committee for interpack 2023 has elected Markus Rustler, President and CEO of Theegarten-Pactec GmbH & Co. KG, to be President and thus Chairman of the committee in its constituent meeting. Rustler was previously vice-president for the last interpack, which could not take place due to the pandemic. Christian Traumann, Managing Director and Group CFO at MULTIVAC Sepp Haggenmüller SE & Co., KG and Roland Strassburger, CEO of SCHÜTZ GmbH & Co. KGaA, have been elected as the Vice-Presidents of the upcoming interpack. The election of all candidates was unanimous.

Markus Rustler: "I'm so happy that everyone has placed their trust in me to hold the office of interpack President. The upcoming edition of the trade fair will be a really special one. Ultimately, the companies in the international packaging industry and related process industry had to do without the last edition of this significant trade fair due to the pandemic, and they are chomping at the bit to see their customers live and in-person and to generate new leads."

In addition, the big themes behind interpack are foreshadowing future developments, particularly those involving the sustainability complex. "The packaging industry is under



Christian Traumann



Roland Strassburger



Rustler Markus

heightened observation from the public in terms of sustainability, but does have effective tools to make a significant contribution to improving the situation, namely circular economy approaches, constantly increasing resource efficiency and intelligent usage of materials", comments Vice-President Strassburger, who is also President of the German Association for Plastics, Packaging and Films (IK).

With the first meeting of the advisory committee, the strategic alignment phase and actual content preparation for the upcoming interpack begins. interpack will take place from 04 to 10 May 2023 at the Düsseldorf Trade Fair Centre.

► [www.interpack.de](http://www.interpack.de)

## Record Numbers Attend Plastics Recycling Show Europe 2021

■ The fifth Plastics Recycling Show Europe (PRSE) exhibition and conference held in November in Amsterdam, The Netherlands attracted a record number of visitors and exhibitors from across Europe. The annual event had a total attendance of more than 4,400 over two days and attracted over 180 exhibiting companies. Over 3,500 attended the in-person event and nearly 900 others attended virtually.

Opened in a virtual presentation by Virginijus Sinkevičius, Commissioner for the Environment, Oceans and Fisheries at the European Commission, the two-day PRSE conference showcased the latest developments in plastics recycling technology and applications, as well as exploring future industry challenges and the legislative landscape within the EU.

"PRSE has been a fantastic opportunity to see new machines, learn about new trends and talk about business, so that all actors in the plastics recycling value chain can take the next steps towards a circular economy," commented Ton Emans, President of Plastics Recyclers Europe (PRE). "The return to live events has clearly been very important to both our visitors

and exhibitors, evidenced by the warmth with which PRSE has been received this year by the plastics recycling community."

Unique in Europe, PRSE brings together exhibitors, visitors and Plastics Recycling Awards Europe finalists representing the whole value chain of the plastics industry including recyclers, machine producers, raw material producers, converters, waste management companies and, increasingly, brand owners, retailers and investors. PRSE facilitates collaborative progress towards the circular use of plastics by showcasing innovation, sharing best practice and bringing partners together to network and do business.

The hybrid event also allowed people unable to visit the event in person to view elements of the two-day conference programme via livestream including the welcome address, keynote speeches and sponsored presentations as well as the announcement of winners of the Plastics Recycling Awards Europe. Online-only visitors were also able to interact directly with exhibitors.

Sian Miles, Sustainable Resources, Director at Berry BPI, urged people to attend PRSE in 2022: "There is so much going on, you can attend the conference sessions, meet all the plastics recyclers in Europe and find out about all the latest innovations. Every year there is something new to see."

The Plastics Recycling Show Europe returns to Hall 12 at RAI Amsterdam on 22 and 23 June 2022.

► [Plastics Recycling Show Europe  
www.prseventurope.com/](http://www.prseventurope.com/)



# A FEEDER THAT FITS SEAMLESSLY INTO YOUR PRODUCTION LINE WITHOUT CUSTOMIZATION?

THIS ONE WILL.



THE ALL-NEW PRORATE PLUS:  
SURPRISINGLY POWERFUL

[www.prorate.plus](http://www.prorate.plus)

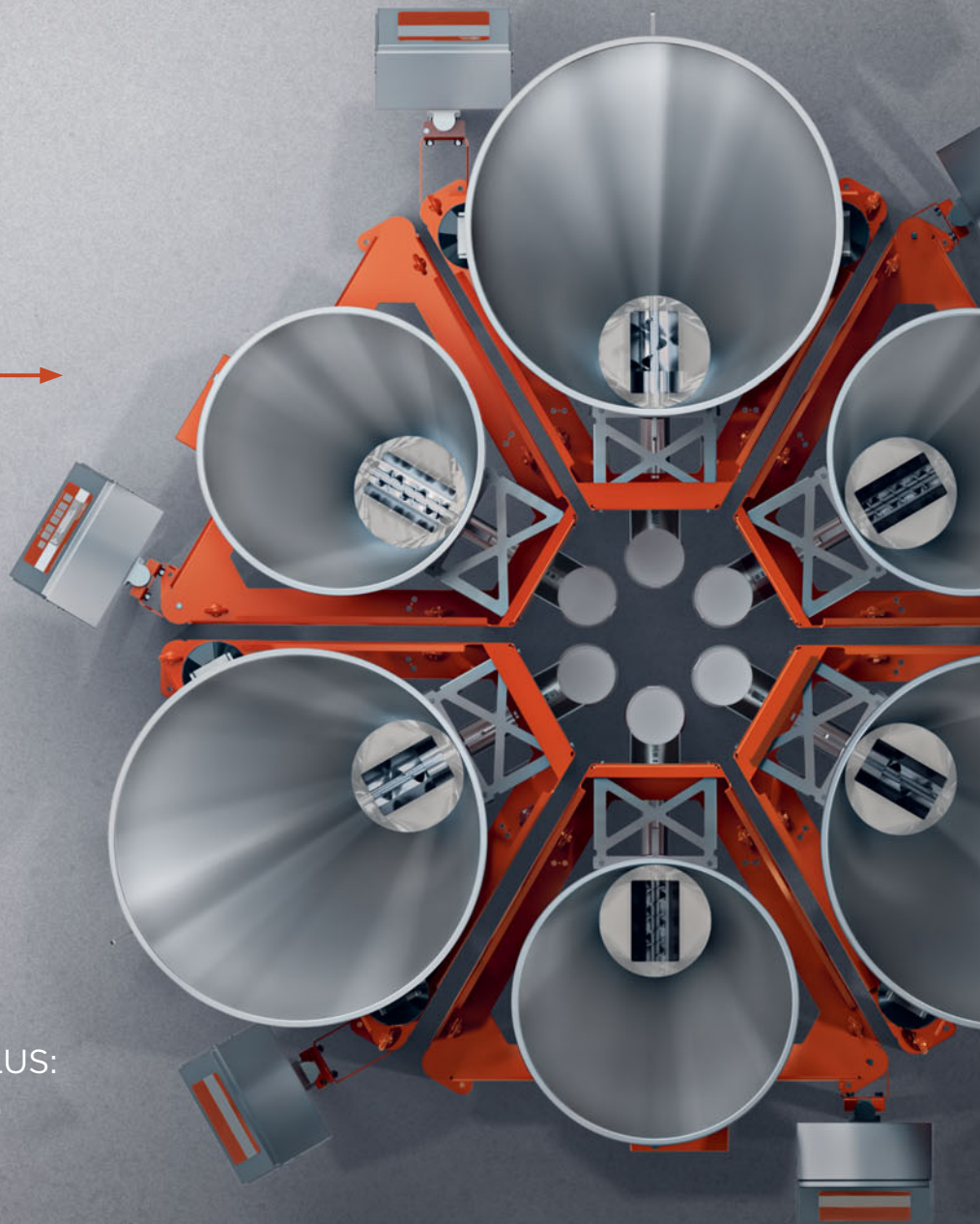

## "Laboratory & Quality Control in Plastics Processing"

■ For the first time, the conference "Laboratory & Quality Control in Plastics Processing" was held in online format on December 8, 2021. VM Verlag as organizer looks back on a successful event. Exclusively positive feedback was received from the 90 participants and the seven speakers.

The event was moderated by the team of experts from the Fraunhofer Institute in Karlsruhe/Germany Dr.-Ing. Jan Diemert (Deputy Division Director, Polymer Engineering, Fraunhofer Institute for Chemical Technology (ICT)) and Dr.-Ing. Kevin Moser (Head of Material Development and Compounding Technologies Group, Polymer Engineering, Fraunhofer Institute for Chemical Technology (ICT)).

All presentations were held in English and focused exclusively on topics related to laboratory systems, metrology and quality control.

After the welcome and introductory words, Dr. Jan Diemert kicked off with his presentation, in which he provided detailed information on inline sensor technology for continuous monitoring of (reactive) plastics compounding processes.

Dr.-Ing. Jan Diemert



Dr.-Ing. Kevin Moser



He was followed by Torsten Clasen (Technical Sales, Promix Solutions AG) with his presentation, which was all about inline viscosity measurement systems.

Oliver Hissmann (Senior Sales Manager FSP, OCS Optical Control Systems GmbH) reported on expert solution for quality control and quality assurance for the plastics processing industry. Oliver Kraushaar (Project & Sales Manager, OCS Optical Control Systems GmbH) provided additional information on the topic in a complementary, plugged-in presentation in the OCS lab.

Dr. Andrew Mellor (Application Market Manager, KRÜSS GmbH) spoke on the topic of flame, corona and plasma activation and put test inks to the test, among other things.

Gernot Schaffler (Collin Lab & Pilot Solutions GmbH) reported in his presentation on the practical implementation of online quality assurance in plastics processing and recycling. Finally, Ralf Kulenkampff (Head of Sales - Plastics, SIKORA AG) gave a detailed lecture about the SIKORA PURITY CONCEPT V, an innovative laboratory system for the optical inspection of granules.

After each presentation the participants had the opportunity to ask questions, which was actively accepted.

Immediately after the conference, many participants expressed their interest in a follow-up event on the topic of laboratory & quality control.

The next event is planned for December 8, 2022, again in an online format.

► <http://lab.extrusion-info.com/>

## New Partnership

■ Logoplaste announced that Ecoibéria and WorldPET, two leading companies in the production of recycled PET flakes and rPET, are now part of the Logoplaste Group. Both companies, located in the North of Portugal, have extensive experience in recycling PET, focusing on the transformation of post-consumer plastic bales into food grade recycled flakes and pellets. The transaction is still subject to customary regulatory approvals.

Currently, Ecoibéria manages 47.500 tons of plastic a year – sorting, grinding, washing and transforming it into usable raw material for the plastics industry. On the other hand, WorldPET recently installed a new Erema VACUNITE® 2 system that is able to supply 12.000 tons of food grade rPET per year.

Jorge Lemos will remain as CEO of both businesses, helping to drive growth as well as ramp up the recently added capacity. For him this new partnership means: "The possibility to continue to evolve and develop an activity that is vital for the green economy. The partnership with Logoplaste aims to ensure that the company I founded in 2005, under the name Ecoibéria, plays an increasingly important role in the evolution of the PET recycling industry globally. Together, we will help

society reach a balance in its consumption habits reducing the consumption of finite natural resources and increasing the usage of recycled materials. Above all, we want to contribute to a sustainable planet today and enabling a safe environment for future generations."

This acquisition is a strategic step for Logoplaste towards a circular economy for plastic packaging. The combination of Logoplaste, a recognized innovation leader, with the extensive recycling knowledge of Ecoibéria and WorldPET, will allow the Group to provide its customers with truly circular packaging solutions that drastically reduce carbon footprint and the impact on the environment.

Logoplaste and its partners are committed to reach 100% of recyclable packaging and a target of 30% recycled content for beverage packaging by 2025.

► Logoplaste  
[www.logoplaste.com](http://www.logoplaste.com)



# Polyamide Compound Manufacturing Reaches New Throughput Dimension

■ Specialty chemicals company LANXESS is now operating another Coperion line to produce Polyamide 6, Polyamide 66 and Polybutylenterephthalate (PBT) at its Krefeld-Uerdingen, Germany, location, making significant steps toward a new throughput range. With this technology, constructed around the high-performance ZSK 92 Mc18 twin screw extruder, LANXESS is producing demanding compounds at throughputs never achieved before. To reach such high output and maintain very good product quality, Coperion equipped the entire system with special features that ensure a high degree of automation, a crucial requirement for this developer and provider of high-performance compounds. Among these features is the ASC strand conveying system from Coperion Pelletizing Technology which automatically conveys polymer strands from the twin screw extruder discharge to the pelletizer. The entire system, built around the ZSK 92 Mc18, is one of several Coperion lines that LANXESS operates in Krefeld-Uerdingen.

Coperion has designed this compounding line as a complete turnkey solution for LANXESS – from engineering to commissioning. From state-of-the-art raw material feeding, to conveying, compounding, pelletizing and classifying technology, Coperion seamlessly synchronized every one of the system’s process steps with each other and logistically integrated them into one steel construction, forming the basis for the compounding system’s fully automated operation. Following a short startup process, its high performance capacity can be fully exploited. Moreover, Coperion designed this compounding line for LANXESS to make optimal use of available space and to assure good accessibility to individual components, as well as short walking distances for operating personnel.

Every key component of this complete solution comes from Coperion’s own development and manufacturing, including the ZSK 92 Mc18 high performance extruder with its very high 18 Nm/cm<sup>3</sup> torque, which takes pride of place when aiming



On its Coperion compounding system, LANXESS produces highly reinforced polyamide compounds at very high throughput rates (Photo: LANXESS, Krefeld-Uerdingen, Germany)

for high throughput rates for reinforced polyamides. The ZSK twin screw extruder is equipped with a twin screw ZS-B side feeder and a ZS-EG side devolatilization unit. Coperion further developed the SK92 die head specifically for polyamide compound manufacturing. With its intelligent heating/cooling concept, a homogeneous temperature distribution is achieved so that strands discharge completely uniformly across the entire width of the die head, even at high throughput rates. Optimized flow geometry allows for gentle handling of the polyamide melt, achieving high compound quality. In the new SK92 design, the die plate can be changed easily and quickly with just a few simple maneuvers’. The fully automatic strand conveying system from Coperion Pelletizing Technology is one of the most important contribution to the entire system’s operation. It automatically guides the extruded strands over a cooling water chute and a downstream conveyor belt to the SP 700 HD strand pelletizer’s intake section. Startup is fully automatic just as the conveying and rethreading of the broken strands is. There is no product loss and running production is not interrupted.

■ Coperion GmbH  
[www.coperion.com](http://www.coperion.com)  
 LANXESS Deutschland GmbH  
[lanxess.com](http://lanxess.com)

## rPET recycling solutions

**viscoSHEET**  
 Up to 100 % rPET and inhouse flakes processable at guaranteed iV-Levels for direct food contact.

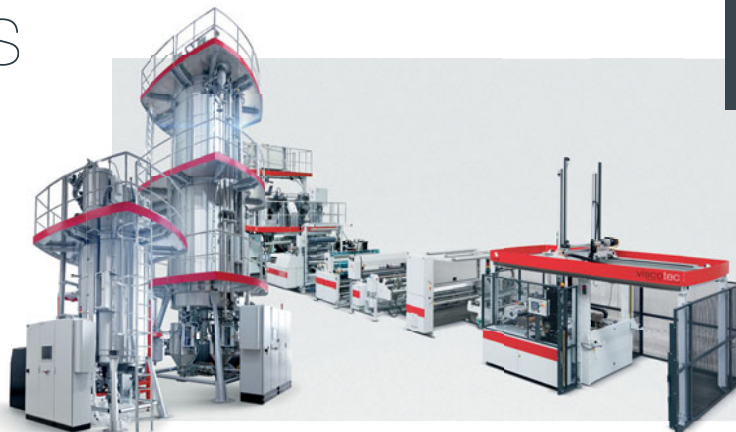

Starlinger Group



## Used Machinery Trading Cooperation for the Middle East Region Started

■ Metalworking and plastics processing manufacturers in the Middle East region stand for high value propositions in production. As a result of currently increasing market dynamics manufacturers need even more flexibility to decrease or increase production capacities short term. At the same time delivery times of new machines have doubled in average due to material shortage and past production stops.

Considering these circumstances GINDUMAC and MAPTEC join forces to enable an easy and professional access for Middle Eastern companies to the global market of used machine tools, sheet metal and plastics processing machinery.

GINDUMAC operates a leading transactional online platform with a wide portfolio of high quality used machinery for metalworking and plastics processing applications. All machines are offered with a full logistics and transaction management service. Buyers from the Middle East get their machines delivered to their production facilities. If needed GINDUMAC can also support buyers with commissioning and installation.

"We are experts for global used machinery transactions. Our customers from the Middle East appreciate our holistic approach to offer the full service until the machine is in production. As we have seen increasing demand for quality used machines with short term availability, we decided to extend our activities in the Middle East region. We are happy to cooperate with MAPTEC as a local expert for the manufacturing industry and manufacturers' needs, states Janek Andre, CEO GINDUMAC."



The management team of GINDUMAC and MAPTEC at SteelFab 2022 in Dubai – UAE. From left to right: Benedikt Ruf (Managing Director - GINDUMAC), Jafar Odeh (CEO - MAPTEC), Janek Andre (CEO - GINDUMAC)

Apart from providing direct access to quality used machines worldwide, the cooperation partners also offer the option to trade in used machines. From single machines to full production lines, GINDUMAC ensures hassle-free transaction management including direct payment and fast pick-up for machines which need to be removed from production facilities.

"Adding used metalworking and plastics processing machinery to our service portfolio extends our service value for our wide network of manufacturers in the Middle East region. Together with GINDUMAC we will offer used machinery solutions for machinery buyers and sellers, underlines Jafar Odeh, CEO MAPTEC."

■ MAPTEC  
[www.maptec.ae](http://www.maptec.ae)

GINDUMAC GmbH  
[www.gindumac.com](http://www.gindumac.com)

## Investment in the Development of R&D Center

■ The laboratory base of the R&D Center from R&P POLYPLASTIC was recently updated by new equipment. One of the main acquisitions was a Shimadzu universal testing machine of a desktop type with an increased traverse travel for carrying out physical and mechanical tests of various materials. The equipment was installed in November 2021.

The testing machine complete with dedicated software has a user-friendly interface. Various accessories such as grips, extensometers, connectors and others, as well as optional software enable one to solve any problem: from routine testing to analysis of new materials.

The machine is equipped with force sensors of 20 kN and 0.5 kN having accuracy of 0.5 % of the force value, which allows testing in a wide range of loads. The thermal chamber of the universal machine makes it possible to perform tensile and flexural tests in the temperature range from -70 to +250 degrees.



The wide functionality of contactless video extensometer for measuring longitudinal and transverse deformations allows solving various complex problems, both in research laboratories and in production.

Moreover, this equipment saves up to 10 to 25 % of energy when in a standby mode compared to conventional machines of previous generation. Absolutely, energy saving is one of the priorities for R&P POLYPLASTIC.

"The results are in line with tensile testing standards for plastics, including ISO 527, ASTM D638. The machine enables one to work with A1 type samples with a measuring base of 75 mm," says Alexander Mavrin, Director of the Scientific and Technical Center for Research and Development of R&P POLYPLASTIC.

Alexander Mavrin also notes that regular investments in modern equipment and the development of the laboratory facilities of R&D Center make it possible to fully apply hi-end technologies in the development of new compounds and therefore to improve the quality of materials that R&P POLYPLASTIC promotes on the market.

■ R&P POLYPLASTIC  
<https://polyplastic-compounds.ru/eng>

## Plastics and Rubber Processing Machines: Sector in Recovery

■ The full-year forecast developed by MECS-Amaplast statistical studies centre shows double-digit growth in 2021 for the Italian plastics and rubber processing machinery, equipment, and moulds industry

“According to our estimates, at the close of 2021 production should be a hair’s breadth from pre-pandemic levels, reaching 4.35 billion euros and an impressive +11.5% with respect to 2020,” states Amaplast president Dario Previero.

The primary driver of recovery in the sector in Italy is the domestic market, which is forecast to close the year with growth of nearly fifteen points and a value of 1.35 billion euros. On the basis of the most recent economic survey of the first nine months of the current year, the surge in orders from Italian customers mainly regards machinery and complete processing lines.

Exports are also playing a decisive role and are expected to return to a value on the order of 3 billion euros, giving a boost to the balance of trade. Indeed, 8 of the top 10 Italian export destination countries, collectively absorbing nearly 60% of the total, show strong growth in demand, with +17% from Poland and +83% from China.

Orders received in the first three quarters of the year, both from Italian and foreign customers, cover production for the next six months and mainly regard machinery. The replacement parts segment, while in the positive range, appears somewhat less dynamic.

As regards applications, it is not surprising to see the highest and most sustained demand for technology from the packaging and medical sectors, while construction and automotive travel at more moderate speeds.

“Naturally, various factors of instability that arose and worsened over the past year – from raw materials costs to difficulty in procuring components, from an increase in energy and transport costs to restrictions on personal mobility – are still unresolved and continue to be sources of concern for companies,” adds Previero.

However, the clear recovery recorded in 2021 – with the first signs of an upswing already observed in the last months of 2020 – gives us good reason to expect performance beyond pre-crisis levels already next year.

“This confirms the robust response capacity of companies in the industry, deriving typically from their flexibility. Faced with the challenges posed by the context and markets, the companies have again succeeded in developing tailor-made solutions in terms of technological content, sustainability, and efficiency,” emphasizes Previero.

# LESUN

## FOCUS

### SCREW | BARREL | SHAFT

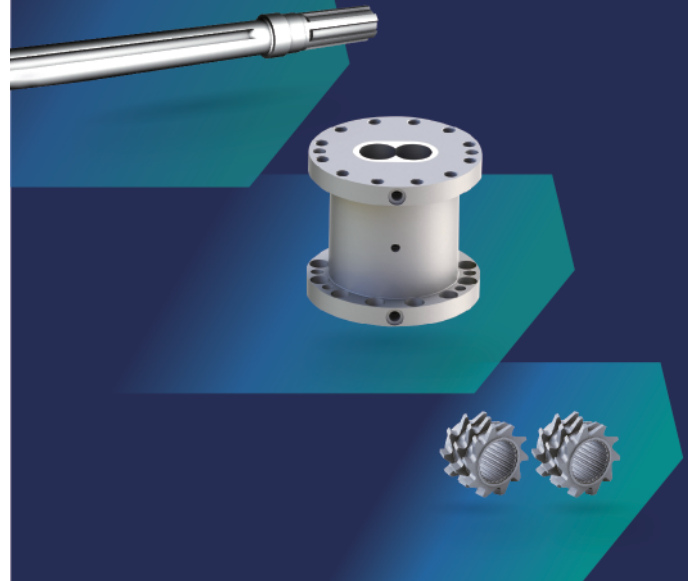

Nanjing Lesun Screw Co.,Ltd.

E:info@lesunscrew.com

www.lesunscrew.com

## Acquisition



HQ in Santa Maria di Sala (VE - Italy)

■ Piovan S.p.A. and IPEG, Inc. announced the signing of an agreement providing for the acquisition by Piovan of 100% of the outstanding shares of IPEG, a U.S. industrial group comprised of the four brands Conair, Thermalcare, Pelletron and Republic Machine.

The combined group will have a workforce of more than 1,800 employees and will operate 14 facilities worldwide, and would have generated pro-forma sales of over €450 million (on the basis of the results for the twelve months ended 30 September 2021).

“We are particularly pleased and proud to combine our skills with those of the IPEG Group, creating the global leader in industrial automation in the plastics sector. Two years ahead of schedule, we have doubled our size since the year of the IPO and we are confidently prepared to meet future challenges and to take advantage of any further aggregation opportunities that may arise.” – says Nicola Piovan, Executive Chairman of the Piovan Group.

“The acquisition of such an important American player and the merger of two of the largest companies in the world in the field of industrial automation for the processing of

virgin and recycled polymers and bioresins will allow us to achieve important growth opportunities on a global scale.” – states Filippo Zuppichin, CEO Piovan Group – “It will also allow Piovan Group to access a formidable customer base in North America, with the possibility - thanks to the international set up of Piovan Group - to follow the investments of the main American multinational corporations in the world. Moreover, it will allow a faster rollout to the American market of the Group’s proprietary technologies particularly in the circular economy. We are convinced that this transaction will create great value for our shareholders”.

The new size will enable further growth in the area of the circular economy and investments in digitisation 4.0. The Group will continue to pursue its strategy of putting its customers, its people and a constant approach to innovation first.

Filippo Zuppichin, CEO Piovan Group



Nicola Piovan, Executive Chairman of Piovan Group



■ Piovan S.p.A.  
[www.piovangroup.com](http://www.piovangroup.com)

## Investments in Sustainable Film Solutions Expanded

■ The RKW Group focuses on the requirements of its customers and is investing in modern facilities at several sites in order to be able to offer future-proof, sustainable solutions. The company will focus on so-called MDO packaging for the food industry. With these innovative solutions, the RKW Group is

*Food is safely and hygienically protected in RKW Horizon brand packaging. The MDO-based PE packaging is fully recyclable*



making a measurable contribution to strengthening the circular economy, because MDO films are 100 percent recyclable.

RKW has many years of experience with MDO technology and is now transferring this into sustainable and safe packaging solutions for food. To this end, the globally active film specialist is expanding its production capacities. With investments in the mid-double-digit million euro range, RKW is not only strengthening its respective sites with new equipment and the right solutions, but also enabling its customers to help shape their own growth.

“We offer materials that meet the needs for lower carbon footprint, higher recyclability as well as the use of more recycled plastics,” said Mussie Berhane, Vice President Sales & Marketing Packaging & Industrial.

There is great demand for sustainable plastic packaging, especially in the beverage and food packaging sector. RKW is





*With modern extrusion lines – here at the Echte, Germany, site – the RKW Group invests purposefully in sustainable solutions for its customers, among others in the food, beverage and industrial packaging sectors*

bringing together its portfolio of solutions for sustainable food packaging under the RKW Horizon brand, which are fully recyclable and meet all hygiene and food protection requirements. A new nine-layer extrusion line is currently being built for this purpose at the Petersaurach site in order to significantly expand production capacities. The line will be able to produce under full load by mid-2022.

Another lever for expanding the circular economy is the use of chemically recycled or bio-based resins. Since RKW is ISCC+ certified, the company can use these sustainable raw materials and offer MDO films that retain all the properties of virgin raw materials.

Different applications require distinct solutions. For outer packaging for beverages, so-called multipacks, the primary goal is to use as much recycled plastic as possible without sacrificing properties such as stability and printability.

At the Saint-Frères site in Ville le Marquet, France, RKW is therefore renewing its machinery. Modern machines, such as the five-shift extrusion line planned for 2023, are much better able to absorb the unavoidable quality fluctuations in the plastics to be recycled and at the same time to reduce production scrap; they are also more energy-efficient than older lines. Multipack films made from recycled plastic from RKW are already used successfully by many global beverage producers.

Cement is an indispensable building material in the construction industry, but it is also a significant emitter of CO<sub>2</sub>. Efficient and responsible handling of the building material is therefore important; it is imperative that cement is protected from moisture before it is used. Filling it in plastic bags like RKW ProVent permanently protects cement from this, even under unfavorable storage conditions – the water vapor barrier is 40 times more effective than paper-based packaging. Moreover, the innovative packaging solution consists of only one material, polyethylene. It can therefore be fully recycled. A new production facility for industrial packaging solutions at RKW's Echte, Germany, site can also use significantly more recyclates.

In this way, RKW is actively contributing to climate protection with targeted investments.



# PLASTIC EXTRUSION SOLUTIONS

PE/PVC/PVCO/RTP/PP/PPR  
Pipe Diameter Range  
**16-2500mm**

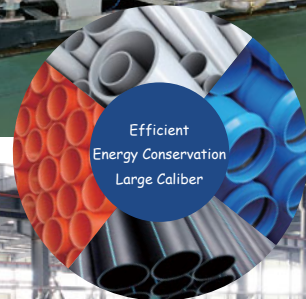

## MEWAR Award "Plastics Recycling Company of the Year 2021"

■ A jury of international waste recycling experts has named CONSENT FZCO as Plastics Recycling Company of the Year 2021.

CONSENT, based in Dubai collects over 6.000 tonnes of PET bottles from waste sites annually and processes these to high quality PET bottle flakes, using a state-of-the-art recycling unit developed and integrated by themselves. Along with PET bottles, PET strapping tape from post-industrial units are also processed by having best practices in the environmental business and sustainability in the region.

In a second process, CONSENT uses Gneuss MRS extrusion technology to produce high quality and high tensile Polyester (PET) strapping by adding recycled PET bottle flakes along with chopped post-industrial PET strap.

The Gneuss MRS extruders remove the need for pre-drying or crystallisation of the PET flakes. Additionally, the Gneuss multiple screw MRS extruder and the Gneuss Rotary Melt Filtration System ensure the optimum product quality.

Since 2019, the "Waste & Recycling Middle East and Africa" magazine gives awards to innovative and sustainability-



Prize Giving Ceremony with CONSENT FZCO

oriented plastics recycling companies in the Middle East. As part of an annual gala event, individuals and organisations from the plastics recycling world are honoured who and which have made an exceptional contribution to ecological and economic sustainability.

"We are extremely proud, to have received this renowned prize" commented a delighted Alan Sakr (CEO of CONSENT). "Since 2013, we have collected 56.000 tonnes of PET from landfill sites in the United Arab Emirates and reprocessed it. If you use the investigations by Stanford University as a basis, whereby one tonne of recycled plastic saves approximately 16 barrels of crude oil, 5,5 m<sup>3</sup> landfill and 5.774 kWh of energy" explained Alan Sakr, "then with our efforts we have in the meantime saved nearly 913.000 barrels of crude oil, 323 kWh of energy and saved of 308.000 m<sup>3</sup> of landscape from landfill".

■ Gneuss Kunststofftechnik GmbH  
www.gneuss.com

Gneuss MRS Extrusion Line



## Record Year Reported

■ In a year blighted by travel restrictions and lockdowns, the leading manufacturer of surface treatment technology beats all previous sales records.

The period since the first lockdown began in April 2020 has had a major impact on world trade and the way companies do business, so Vetaphone is more than happy to report a huge boost in orders across the board that saw it return a year-end total that will not only surpass expectations but exceed all previous years in the company's long history.

Speaking for the company, VP Sales & Marketing Kevin McKell explained: "We were quick to assess the situation and adapt our sales and marketing approach to suit the new trading conditions. With travel either impossible or severely limited we had to find alternative ways for face-to-

face contact with customers, and the actions we took have clearly worked well!"

With trade fairs being cancelled on a rolling basis, Vetaphone took the bold decision to withdraw from exhibiting at all future events, whether large or small. Instead, the company officially opened its new Showroom and Demo facility in May that is fully equipped with working corona and plasma technology and offers both in-person and on-line appointments via a video link. Allied to the adjacent Test Lab facility that it opened in 2020, Vetaphone now has a permanent trade fair stand of its own that is available 24/7, if necessary.

"We've had great customer response to the new showroom and the fact that we can actually demonstrate the equipment – something we could never do at Drupa or Labexpo – and it's really started to pay dividends in terms of orders secured. We know that many of our customers are unlikely to ever visit us in Denmark – now we can take

our technology to them wherever they are in the world," he added.

The new trading conditions also had an impact on how the company promoted itself and publicised its activity. Marketing Director Jeannette Woodman explained: "We quickly switched our focus from a 'broad-brush' approach to one that is far more zoned in on the different sectors and parts of the world. By refining our use of the latest in computer and electronic communications we have been able to impact target markets with information that is specific to individual requirements – and at a fraction of the cost of attending a major international expo!"

For Vetaphone, the new trading conditions have opened new business opportunities, and in addition to reporting a record sales year, 2021 has seen the company move to the No 1 spot worldwide in surface treatment technology. As Kevin McKell put it: "We were the first, so to be at No 1 in our 70th year is a fantastic achievement. Bring on 2022!"



The newly opened Showroom in Denmark is a permanent display of working surface treatment technology for in-person or online presentations and demos

► Vetaphone A/S  
www.vetaphone.com

## Joint Venture in China Established

■ The Chinese Fujian Highsun Engineering Plastics Co, Ltd and AKRO-PLASTIC GmbH, a member of the German Feddersen Group, have signed an agreement on 22 December 2021 for future cooperation in the Greater China region (China, Hong Kong, Macau and Taiwan).

Subject to approval by the relevant antitrust authorities, Highsun will acquire a 51% stake in AKRO Engineering Plastics (Changzhou) Co, Ltd. from AKRO-PLASTIC GmbH. The remaining 49 % of the shares in the company will continue to be held by AKRO-PLASTIC GmbH.

The joint venture will start its activities on the market after the completion of the share transfer. Until then, AKRO Engineering Plastics (Changzhou) Co., Ltd. will continue its business operations as usual. The joint venture will oper-

ate under the name Highsun AKRO Engineering Materials (Changzhou) Co., Ltd.

AKRO-PLASTIC GmbH will support the JV with its know-how in the areas of research and development as well as engineering. The JV will also use AKRO-PLASTIC's ICX technology and obtain an exclusive licence to manufacture and market in the Greater China region the products previously manufactured by AKRO-PLASTIC in the People's Republic of China. Outside the Greater China region, AKRO-PLASTIC will continue to hold the exclusive rights to its brands, formulations and technologies and will continue to operate completely independently there as before.

The quality standards and processes remain unchanged. No changes to the material formulations are planned, the production and quality assurance processes will remain unchanged and the qualification standards for raw materials will not change either.

In the future, customers will continue to be able to obtain AKRO-PLASTIC products of the same quality from all plants worldwide, including the JV plant in China.

Highsun is the fully backward integrated world market leader for PA 6 and has an excellent infrastructure as well as extensive relationships in China. AKRO-PLASTIC has leading PA compounding technology as well as a strong position as a supplier to a large number of global companies in its customer base.

The combination of the strengths of both partners will enable the joint venture to build a leading position for PA compounds in China. The shareholders intend to develop the joint venture into a leading player in the Chinese engineering thermoplastics market.

Unfortunately, not all contract partners were able to be present at the signing of the contract in Fuzhou/China. From left to right: Linda Xu, Sales Director; Qi Jiwei, Operations Manager and Deputy General Manager (both AKRO Engineering Plastics (Changzhou) Co., Ltd.); Chen Jianlong, Chairman, Highsun Holding Group; Wilfried Jobst, General Manager AKRO Engineering Plastics (Changzhou) Co., Ltd.; Chen Zhong, President, Highsun Holding Group; and Shen Zhonghai, Vice Finance Director, Highsun Holding Group



► AKRO-PLASTIC GmbH  
www.akro-plastic.com

## Plant Engineering Expertise Expanded



The majority shareholding by Zeppelin Systems gives KITZMANN backing for global growth, from left: Guido Veit (Vice President Sales Projects, Zeppelin Systems); Nico Gräfe (Magdalena KITZMANN GmbH); Albrecht Gräfe (Magdalena KITZMANN GmbH); Rochus Hofmann (Managing Director, Zeppelin Systems)

■ The plant engineering company Zeppelin Systems is continuing its growth course and has acquired the majority of shares in Magdalena KITZMANN GmbH with effect from January 1, 2022. Zeppelin Systems is thus further expanding its expertise

in the field of so-called performance materials and ensuring its customers comprehensive support in this market segment from a partner with many years of expertise.

With a broadly based portfolio, Zeppelin Systems serves not only a wide range of market segments but first and foremost, diverse customer groups with its high level of expertise in plant engineering. The company has a reputation as an expert in the handling of solid as well as liquid raw materials and primarily covers the process steps of storing, conveying, weighing, dosing and mixing in various industries. "Our broad portfolio offers our customers security for long-term investments. With the majority shareholding in KITZMANN, we have secured in-depth expert knowledge, especially in the field of performance materials, and can offer our customers even better plant concepts," explains Rochus Hofmann, Managing Director of Zeppelin Systems.

The owner-managed Magdalena KITZMANN GmbH company optimally complements the portfolio of the plant manufacturer not only through its correspondingly high-quality standards, but above all by providing optimal support to the PVC and chemical applications market segments through the new partnership. As a specialist for customized and process-safe complete plants, KITZMANN stands for reproducibility along with functional and operational reliability. The 360° range of services includes engineering through to commissioning of individual components as well as manufacturing turnkey plants for liquid or solid handling.

Despite the takeover, KITZMANN remains an independent company and continues to be managed in equal parts by Albrecht Gräfe and his son Nico Gräfe.

■ Zeppelin Systems GmbH  
[www.zeppelin-systems.com](http://www.zeppelin-systems.com)

## Industrial Operation Started

■ Official ceremony marking the launch of a new production facility took place in Engels, Saratov Region, on January 21, 2022, with participation of the region Governor Valery Radaev. Alexander Pavlov, General Director of R&P POLYPLASTIC and Evgeny Parshikov, General Director of Saratov Polymer Materials Plant pressed the symbolic start button.

After the lines started, participants of the opening ceremony inspected the entire production chain and observed operation of the equipment and finished products packaging.

Saratov Polymer Materials Plant investment project was implemented with the support of the region Government. On December 12, 2020, Ministry of Economic Development of the Saratov Region signed the Order to include Saratov Polymer Materials Plant in the register of participants in region investment projects. Civil works started in March 2021, and the first equipment arrived at the plant in May-June. Commissioning of the lines began on December 10, 2021.

After reaching full production capacity, the plant will produce about 20.000 MTY of compounds based on polypropylene and polyamide to replace imports of engineering plastics in the domestic market and increase export sales. Two energy-efficient high-tech lines based on Blue Power extruders delivered to Saratov Polymer Materials Plant by Krauss Maffei (Germany) are the first extruders of this class in Russia. The lines themselves have modern equipment from leading world and domestic manufacturers: Brabender Technologie, MAAG, Moretto. The installation was carried out by the Russian company Polytechnika.

The total investments in fixed assets during the implementation of Saratov Polymer Materials Plant project amounted to more than 4.8 million EUR. The enterprise created 30 high-tech jobs. The production is automated as much as possible; a shift of only 5 people is required to ensure the operation of the lines.

■ R&P POLYPLASTIC  
<https://polyplastic-compounds.ru/eng>

## Efficient Powder Coating Manufacturing Using Twin Screw Extruders

■ KANSAI HELIOS Group has just expanded its production of coatings at two locations – Helios Coatings Italia and Helios Coatings Deutschland – using a Coperion twin screw extruder at each site. Two ZSK Mv PLUS extruders with 43 mm screw diameters for powder coating production were installed practically concurrently, one at the Riese Pio X location in the Venice region of Italy and the other at the Buchholz, Germany site. KANSAI HELIOS specifically decided upon Coperion’s twin screw extruder technology, due to its very high dispersion performance, and its suitability to a very broad range of recipes. KANSAI HELIOS values how Coperion ZSK extruders fulfill very high quality requirements, as well as their efficient operation and flexible options when manufacturing powder coatings.

With these two ZSK twin screw extruders, KANSAI HELIOS is deliberately expanding its powder coating production around a technology that has built in flexibility for future challenges. ZSK extruders’ speed, residence time and throughput can be modified quickly and individually for the requirements of new powder coating recipes.

Coperion’s ZSK Mv PLUS twin screw extruders have already been used successfully for manufacturing high-quality powder coatings for many years. Extruders in this series stand out particularly for their deep cut screw channels with a 1.8 Do/Di (outer to inner) screw diameter ratio, resulting in a large free screw volume. Powders with low bulk density and poor intake behavior, often used in powder coating manufacturing, can be fed into the process in large quantities. At the same time, thanks to the ZSK Mv PLUS’s twin screws, even recipes with high filler content are intensively dispersed while still being gently handled. Distribution of individual raw materials in the powder coating premix proceeds reliably and homogeneously. The result is a high-quality powder coating.

All of the ZSK extruders’ connections, water supply and cables are protected by easy-to-clean casings and are still eas-

*KANSAI HELIOS Group has just expanded its powder coating production at two locations with ZSK twin screw extruders from Coperion (Image: Coperion, Stuttgart)*

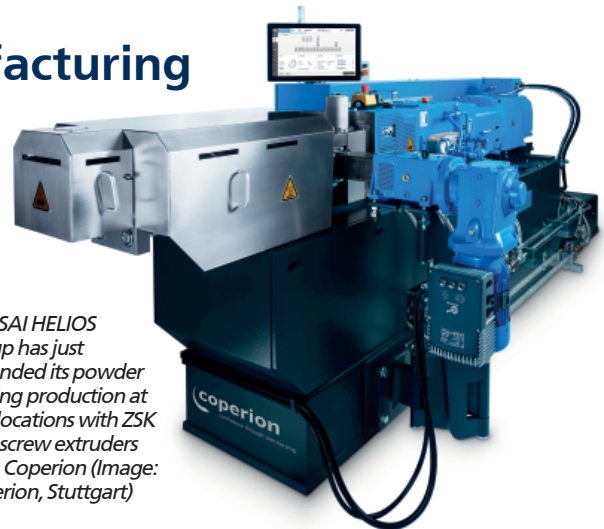

ily accessible. The closely intermeshing twin screws ensure optimal self-cleaning in the process section, making recipe changes quick to execute.

Coperion has equipped the ZSK 43 MV PLUS extruders for KANSAI HELIOS with a number of smart features to simplify machine operation; both twin screw extruders are operated using the new, user-optimized CSpro control system. Complexity of its user interface is greatly reduced in comparison to previous versions, without losing any well-known functionalities and it can be operated intuitively by touch. Information can be inserted on demand. The risk of possible operator error is markedly reduced.

Additionally, both of KANSAI HELIOS’ ZSK extruders have been equipped with electronically secured maintenance doors at the gearbox lantern. As soon as the extruder’s screw shafts come to a complete stop, service personnel can open the gearbox lantern without tools. The screw shaft coupling can be accessed safely and quickly, leading, for example, to a clear reduction in downtime during machine maintenance and a resulting increase in the machine’s efficiency.

■ Coperion GmbH  
www.coperion.com

## Sales Team for Web Inspection Systems Expanded

■ Film inspection systems have become essential in high-end markets such as the pharmaceutical, medical, hygiene and food industries. Since 1st January 2022, Andreas Peterhanwahr has been supporting OCS sales for web inspection systems (FSP) as Senior Sales Manager FSP.

Peterhanwahr brings more than 12 years of experience in technical sales of customer-specific sensor applications as well as industrial measurement and control technology for the automotive supplier industry, among others, and supports OCS in achieving their corporate goals with great strides.

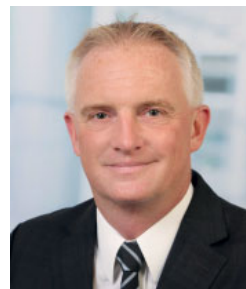

*Andreas Peterhanwahr*

■ OCS Optical Control Systems GmbH  
www.ocsgmbh.com

## From PET Bottles Straight to Food Contact Grade r-PET Packaging

■ AMUT's strategic partnership with EREMA contributes to accelerate the transition towards a greener world. In summer 2021, EREMA in collaboration with AMUT has finalized the installation and commissioning of ALTO packaging's first extrusion line for food grade PET sheets in New Zealand market. At the ALTO Plastic Packaging site, in Albany, the plant now processes 100 % washed post-consumer flakes into 100 % food contact grade monolayer thermoforming sheet. In New Zealand, this milestone represents the first system to be installed for this special application.

The plastic packaging company ALTO, a division of PACT Group, invested for this new food grade PET sheet extrusion line as a part of Pact Group's vision to lead Circular Economy through Packaging in Australia and New Zealand.

Thanks to the direct combination of VACUREMA® PET recycling technology and the AMUT Inline Sheet production technology there is no longer any extra process stage. This is, because the melt goes straight from the VACUREMA® 1716 T Basic to the AMUT plant without the detour of pelletising. The post-consumer PET material is already decontaminated and pre-dried prior to extrusion in the vacuum reactor of the VACUREMA® Basic, with a throughput of up to 1,500 kg per hour. After high capacity filtration by EREMA's SW-RTF backflush filter and online IV measurement, the melt goes directly into the AMUT Inline Sheet plant where it is processed into thermoforming sheet from 0.15 mm till 1.2 mm thickness. The monolayer thermoforming sheet produced from pure rPET is not only 100 % food contact compliant, it also fulfils the FDA and further regulations. At ALTO it is further processed into trays and food containers.

AMUT played its part by providing a full range of downstream equipment ranging from the Automatic Tdie, three



rolls stack calender with automatic gap control and motorized cross axing unit, lamination unit for welding and barrier films, thickness control gauge to anti-static silicon coating unit, fully automatic two shafts turret winder and in line edge trims grinding and recycling.

The special features of this extrusion line come from the complete automatic and easy management of the line. This is due to the new Amut's software including the Easy Start and Easy Change functions that will allow the operator to start the extrusion line and change product formats in automatic mode.

EREMA and AMUT are long-term partners in the Inline Sheet sector. EREMA's VACUREMA® technology is currently in use in more than 100 Inline Sheet facilities around the world, also for PACT Group companies in Australia.

AMUT  
www.amutgroup.com

EREMA  
www.erema-group.com

## Sales Coverage in Germany Boosted

■ Global market leader in surface treatment, Vetaphone, has increased its sales coverage of the key German market with the appointment of Ahmed Türkmen as Area Sales Manager with immediate effect. Qualified with a Technical Diploma in IT, he brings more than 10 years of experience in Corona treatment technology to the company and a range of skills that include order processing, sales support, and

sales team management across many western European countries, as well as Russia.

Commenting on his new job, Ahmed stated: "I am delighted to be joining the No. 1 company in surface treatment and look forward to using my well-established customer development skills to grow our business in the German market. I like to get close to my customers and I know that has great synergy with the way that Vetaphone has always operated."

Speaking for Vetaphone, VP Sales & Marketing Kevin McKell observed: "Ahmed is a very valuable addition to our sales team and has a solid background of success with surface treatment technology in Germany. He joins us at a most exciting time as we look to build on last year's record sales figures."

Ahmed Türkmen has joined Vetaphone as Area Sales Manager for Germany

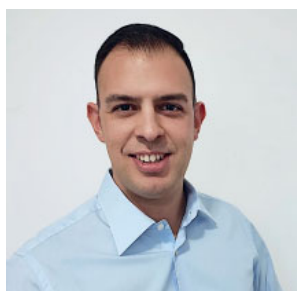

Vetaphone A/S  
www.vetaphone.com

## Strategic Partnership

■ Borealis, one of the world’s leading providers of advanced and circular polyolefin solutions and a European market leader in base chemicals and fertilizers, and the Reclay Group, international experts in environmental and material recovery management, announced that they have joined forces to satisfy increasing market demand for the supply of recyclate material for use in high-end plastic applications. This partnership will optimise the recycling value chain starting with Germany, one of the largest European recycling markets. The partnership further accelerates the transition to plastics circularity by enabling customers and other value chain partners to meet their own sustainability targets. The new agreement provides Borealis with access to a secure and steady supply of feedstock in the form of lightweight packaging (LWP) waste collected by Reclay’s Extended Producer Responsibility

*The plastic packaging waste is processed at Borealis’ own state-of-the-art recycling plants. Shown here: Borealis Recycling Plant Ecoplast in Wildon, Austria (© Borealis)*



*The partnership secures plastic waste from Reclay for Borealis to convert and revalorise in high-quality recyclate materials (© Raan GmbH)*

(EPR) scheme in Germany. The plastic packaging waste is then processed at Borealis’ own state-of-the-art recycling plants, thus extending the range of applications for which recycled plastics can be used. This in turn enables value chain partners, customers, and brand owners to meet recycling quotas and increase the volume of plastic recyclate used in products and applications.

“The reliable supply of high-quality recyclate is a prerequisite for a functioning circular economy,” explains Lucrece Foufopoulos, Borealis Executive Vice President Polyolefins, Innovation & Technology and Circular Economy Solutions. “Working together with the Reclay Group is a strategic step towards value chain integration in securing plastic waste feedstock and improving recyclability. This will enable our customers and partners to achieve their circularity goals and reduce their overall carbon footprint, and at the same time underpins our Borealis journey towards more sustainable living.”

■ Borealis AG  
[www.borealisgroup.com](http://www.borealisgroup.com)

Reclay Group  
<https://reclay-group.com>

## Market Study Polypropylene

■ More and more countries are trying to limit the demand for plastic packaging. In Germany, for example, lightweight plastic bags is banned from January 2022. Nevertheless, demand for polypropylene (PP) continues to grow. “This standard plastic is not only used for packaging, but also for numerous other applications,” explains Oliver Kutsch, Ceresana’s managing director: “The spectrum of applications ranges from textile fibers, household appliances and car parts to water pipes and concrete additives.” The market research institute Ceresana has now examined the global market for polypropylene for the sixth time. The latest edition of the polypropylene market analysis forecasts that revenues for this versatile, easily recyclable variety of plastic will grow by an average of 5.6% per year until 2030.

### Substantiated Polypropylene Market Data

Chapter 1 provides a comprehensive depiction and analysis of the global market for polypropylene – including forecasts up to 2030: for each region, the development of demand,

revenue, and production of the PP industry is presented. Additionally, the individual application areas of polypropylene are considered. Chapter 2 of the PP Report looks at the most important 27 countries individually. Demand, revenue, trade and production are shown in each case. Demand is broken down by application, product type (homopolymer/ copolymer) and technology (injection molding, film and sheet extrusion, other extrusion and other processes).

Chapter 3 of the market study provides useful company profiles of the most important polypropylene manufacturers, clearly arranged according to contact details, revenues, profit, product range, production sites, capacities and profile summary. Detailed profiles are provided by 94 manufacturers.

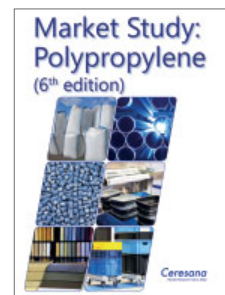

■ Ceresana  
[www.ceresana.com/en/market-studies/plastics/polypropylene/](http://www.ceresana.com/en/market-studies/plastics/polypropylene/)

## New Additive Solutions for Mechanical Recycling of Plastics

■ BASF has launched IrgaCycle™, a new range of additive solutions to address the imminent needs in plastics recycling.

The plastics industry is seeking ways to incorporate higher content of recycled polymeric material in all major applications to meet sustainability goals, while facing growing consumer concerns and stricter regulatory requirements to reduce plastic waste. Hereby a major challenge is to mitigate quality deficiencies of polymers arising from thermal and mechanical stress during the recycling process.

Recycled plastics often contain impurities and polymer contaminants that accelerate polymer degradation, which change the material properties. Consequently, recyclers and plastic converters are facing quality and performance issues while processing recycled polymeric material. Formulated additive packages improving the properties of these recycled plastics can be a solution for this challenge.

The production of plastics from mechanical recycling is expected to almost triple by 2030, driven by improved technologies and regulation. This corresponds to a growth of around 10 percent per year," says Dr. Thomas Kloster, President of BASF's Performance Chemicals division. "With IrgaCycle we are expanding our existing portfolio step by step by specific solutions for recycling to support the circular economy goals for plastics."

The new IrgaCycle range includes additive solutions that can help increase the percentage of recycled content in several end-use applications. These solutions address specific quality issues associated with recycled resins, such as

limited processability, poor long-term thermal stability and insufficient protection from outdoor weathering. At launch, the product line includes a range of different additive formulations, with more to follow in the future.

IrgaCycle PS 030 G enhances long-term thermal stability in rigid applications, mainly for recycled HDPE, polyolefins and mixed polymers.

IrgaCycle PS 031 G improves processing and long-term thermal stability of recycled LDPE and LLDPE for incorporation into films and related flexible packaging applications.

IrgaCycle PS 032 G provides processing stability and long-term thermal protection for recycled PP and polyolefin blends containing impurities.

IrgaCycle UV 033 DD combines weathering stability with enhanced thermal and processing stability for reclaimed HDPE and PP blends for re-use in outdoor goods.

IrgaCycle XT 034 DD rejuvenates processing, long-term heat stability and helps neutralize impurities of the "first life" of the plastic, and with this improves mechanical properties of polyolefin recyclates.

A specific advantage of these blends lies in their ready-to-use product forms, which are easy to apply in the recycling steps. The granulated non-dusting product form ensures safe and easy dosage during converting or compounding of reclaimed material.

■ BASF Plastic Additives  
[www.plasticadditives.basf.com](http://www.plasticadditives.basf.com)

## Five Times More Flakes from Recycled PET Bottles

■ Herbold Meckesheim obtained a new major order in December: the company will supply a large-scale plant for plastic recycling to Fantastic Plastic. Fantastic Plastic is considered to be the producer of the highest quality PET flakes in Russia. The first production line of the recyclate manufacturer was also supplied by the Meckesheim/Germany-based special machinery manufacturer Herbold.

In 2019, Fantastic Plastic's plant in Nizhny Novgorod, Russia, went into operation. Since then, together with Herbold

Meckesheim and the downstream manufacturers, elaborate trials have been conducted to refine the process. The goal that has now been achieved is that the quality of the granules meets the strict regulations for food packaging and can be used bottle-to-bottle.

The fact that Herbold maintains a technical center at its headquarters in Meckesheim, which can be used for trials of all kinds, was of great benefit here.

Thanks to closely coordinated planning – the project started in January 2022 – periods of downtime in main production are largely avoided during the installation of the machines. Fantastic Plastic aims to use the new recycling line to boost its granulate output to 35,000 metric tons per year, a fivefold increase. The Russian company has invested a good 10 million dollars in this project. It is expected to create around 180 new jobs at the site.



■ Herbold Meckesheim GmbH  
[www.herbold.com](http://www.herbold.com)



## New Location

■ Just under a year ago, the EREMA Group started to repurpose the premises of Gruber & Kaja in St. Marien, which they took over as a reserve site in January 2021. In the meantime, a lot is going on there.

“When this site came up for sale, it only took us a few days to decide to buy the 40,000m<sup>2</sup> plot, including the workshop hall, which has an area of 15,000m<sup>2</sup>,” says Manfred Hackl, CEO of EREMA Group GmbH. Around EUR 20 million was invested in the purchase, as the site offered the opportunity to increase production capacity by 60 percent in the immediate vicinity of the company headquarters in Ansfelden.

The fact that this site is now already being used so intensively was not envisaged at the time, because at the end of 2020 the company was just completing the expansion to their headquarters in Ansfelden, involving an investment of around EUR 17 million. 20 new jobs have already been created as a result, with a further 30 to follow in the next few months. By the time the new site is completed, the total number of new jobs will be up to 150.

This development is due to the high demand for the EREMA Group’s plastics recycling technologies and the trend towards ever-larger recycling plants. “Just in December, we delivered a VACUREMA® system to Brazil that will produce up to 40,000 metric tonnes of recycled PET (rPET) per year. That is equivalent to recycling around 1.1 billion 1.5-litre PET bottles. This site provides the perfect conditions for building this scale of machine,” says Hackl.

Since January 2021, part of the existing office and hall space at Kunststoffstraße 1, as the site’s address is now called, has been occupied by companies and depart-



*From the left: Walter Lazelsberger Mayor of St. Marien, Michael Heitzinger Managing Director EREMA GmbH, Markus Stölnberger Managing Director UMAC GmbH, Markus Achleitner Upper Austria’s Minister for the Economy, Markus Huber-Lindinger Managing Director EREMA GmbH and Manfred Hackl CEO EREMA Group GmbH*

ments of EREMA . UMAC, a subsidiary specialising in servicing and trading previously owned recycling machines, which was severely short of space at its main location in Styria, moved its entire production and administration to St. Marien. Large areas of hall storage space were adapted for both UMAC and EREMA. The paint shop was also relocated from Ansfelden to St. Marien, and another hall was equipped for building large-scale VACUREMA® systems. Production in this workshop is now being ramped up step by step.

**EREMA Group**  
www.erema.com

## Functions in Customer Portal Added

■ The Swiss trading group Meraxis has further expanded its digital customer portal for the procurement of prime and recycled materials: Effective immediately, customers can send material requests and place and manage their orders directly in the “Meraxis Customer Portal”.

“The digital solution significantly simplifies the entire procurement process for our customers and, above all, saves them valuable time,” says Michael Grysczyk, Head of Digital & Disruptive Business at Meraxis. “The portal can be accessed around the clock, giving buyers the flexibility they need in their day-to-day work. Of course, our professional sales consultants are still available to all customers.”

Meraxis is one of the first plastics distributors to offer such a customer portal. Here, users get a 360° overview of current and past material requests, offers, and orders. In addition, delivery times, delivery statuses, documents,

invoices and payment statuses are displayed. Buyers can create new requests in a few steps. For this purpose, older inquiries can be copied and adapted if necessary. The central portal also provides access to up-to-date market data and raw material price developments.

“Our customer portal bundles all relevant data and documents and thus creates full transparency,” says Oliver Zehnder, product manager for the customer portal. “For longer-term contracts, the digital platform also shows our customers their monthly raw material consumption and the volumes still open until the end of the contract.”

**Meraxis Group**  
www.meraxis-group.com

## “Mixing Possible” – The CMQ Container Mixer Sets New Standards in Safety and Productivity

■ Mixing of polymer powders, additives, pigments or flours in the plastics, chemical, masterbatch and food industries not only requires comprehensive know-how in process engineering, but also a fundamental understanding of the material properties. The plant manufacturer Zeppelin Systems has been a pioneer in this field for years and, with its CMQ container mixer, supplies a product that meets the requirements for mixing quality, dispersion, efficiency and, above all, safety. This is proven by the recently issued EU type examination certificate according to ATEX Directive 2014/34/EU, according to which the CMQ container mixer is approved for mixing bulk materials that require a design in equipment category 1/3 D (zone 20 inside, zone 22 outside).

Explosive substances do not always reveal their physical properties at first glance. For example, even everyday products such as plastics, additives or flour can lead to a dust explosion during mixing if they come into contact with an ignition source in a certain concentration as a dust-air mixture. This can be, for example, a static discharge or a hot surface that ignites the mixture. If such an event happens, it can cause a lot of damage to the plant. Therefore, it is important to avoid potential hazards in advance of the mixing process. The patented CMQ container mixer from Zeppelin Systems proves through its EU type examination certificate that it can meet the requirements of dust explosive substances. Thus, it not only offers the operator a high degree of safety, but also makes inerting obsolete. This allows the user to concentrate on the most important thing: the optimum mixing results.

In addition to meeting high safety standards, the CMQ container mixer guarantees very high dispersion thanks to its innovative design. The airfoil mixing tool in combination with the winglets ensures good formation of the mixing stream, fast material movement and keeps mixing resistance low. This protects the products and can reduce the temperature rise to a minimum, for example by a maximum of 2 degrees Celsius per minute for a powder-coatings premix.

Furthermore, the airfoil shape causes a high suction effect on the material. This results in a high lifting force and a faster mixing. Thus, the customer obtains the desired mixing result within three to four minutes.

Another advantage of the mixing tool is the high distance to the bottom and wall of the mixing container. This causes hardly any material pressure and thus reduces deposits to a minimum.

Compared to conventional container mixers, Zeppelin Systems has optimized the critical components to simplify the cleaning process many times over and save valuable time during cleaning. The entire mixing head, the mixing tool and the mixing container are considered critical. If deposits accumulate here, cross-contamination can occur in following mixes, making the mixture



*Mixing with the CMQ container mixer takes place in almost all applications without inerting*

unusable for further use. Therefore, Zeppelin Systems has designed its mixing head significantly different from conventional mixing heads. By replacing the usually trough-shaped mixing head with a polished, flat plate cleaning is much easier and faster. This is supported by the very large distance between the mixing tool and the mixer bottom, which really facilitates the accessibility. In addition, almost no deposits on the tool and mixing plate contribute to a fast cleaning process.

The shape and polished surface of the mixing tool of the CMQ container mixer also prevent deposits. In addition, the mixing tool is very light, weighing only 17 kilograms for a 1,000-liter mixer, so the user can disassemble and replace it very quick and easy. This saves valuable time when operating the mixer by reducing cleaning time by up to 80 percent. This not only increases productivity, but also machine availability, saving five-figure sums per year.

*Authors:*  
*Hendrik Schluckebier,*  
*Product Manager Mixing Technology*  
*Julia Meyn,*  
*Team Manager Marketing*

## Science Award 2020

■ The ZwickRoell Science Award honors outstanding scientific work in the field of mechanical testing in an annual competition. More than 200 scientific papers from around 30 countries were examined this year. The winners of this year's competition are Horacio D. Espinosa, Denis Dalli and Anja Gosch.

Decisive criteria for the evaluation of the submitted works were criteria such as the innovative character of the applied testing method, its scientific content and the degree of interdisciplinary cooperation.

The winner of the EUR 5,000 first prize and recipient of the Paul Roell Medal is Horacio D. Espinosa from Northwestern University (USA) for his paper entitled: "In situ Wear Study Reveals Role of Microstructure on Self-Sharpening Mechanism in Sea Urchin Teeth". The contribution was convincing due to the unusual use of sea urchin teeth.

The second prize of EUR 2,000 went to Denis Dalli from Queen's University Belfast (UK) for his paper entitled: "Compressive intralaminar fracture toughness and residual strength of 2D woven carbon fiber reinforced composites: New developments on using the size effect method". The paper provides significant new insights into the material behavior of composites with high industrial relevance.

Third place and EUR 1,000 in prize money went to Anja Gosch from the University of Leoben (Austria) for her paper entitled: "Fatigue characterization of polyethylene un-



*First place: Horacio D. Espinosa from Northwestern University (USA) receiving the certificate from Lorrain McLean (Sales Manager ZwickRoell North America) (Source: ZwickRoell)*

der mixed mode I/II conditions". This provides new insights into the fatigue of polymer pipe materials under combined mode I/mode II loading.

On December 7, 2021, the ZwickRoell Science Awards 2020 ceremony was held as a digital event. During this event, the three award winners were given the opportunity to present their work in short talks and discuss questions with the event participants.

■ ZwickRoell GmbH & Co. KG  
www.zwickroell.com

## POWTECH 2022 – Change of Date

■ The pandemic continues to disrupt the international events calendar for mechanical process engineering and analytics in 2022. Following in-depth consultation with the honorary sponsors, the Exhibition Advisory Board and many registered exhibitors, NürnbergMesse as organizer has now decided to postpone POWTECH 2022, the international Leading Trade Fair for Powder & Bulk Solids Processing and Analytics, by four weeks. It will now be held at the Exhibition Centre Nuremberg from 27 to 29 September 2022, in parallel with FACHPACK, the European Trade Fair for Packaging, Technology and Processing.

"That means we can offer the bulk solids sector an exhibition date outside the summer holidays, which is particularly

convenient for our customers from southern Germany and the Mediterranean region," says Heike Slotta, Executive Director Exhibitions, NürnbergMesse. "In recent days we have had in-depth discussions with the exhibitors at POWTECH and asked them about their preferred dates," says Slotta. "It is extremely important for us to make this decision in conjunction with our customers – with the sector for the sector, you might say. The result of the survey was clear: The majority opted to hold it on 27-29 September 2022. By holding FACHPACK in September last year, we showed that we were able to run highly successful trade fairs even in the middle of a pandemic. That's why we're also really looking forward to holding a successful live event for the bulk solids sector."

Holding POWTECH 2022 in parallel with FACHPACK will thus highlight the entire value chain from product manufacture through to packaging. Running POWTECH and FACHPACK in tandem will also create additional synergies in the areas of processing and packaging.

■ POWTECH,  
www.powtech.de  
FACHPACK  
www.fachpack.de



# The US Plastics Industry in 2021

By Perc Pineda, PhD, Chief Economist,  
Plastics Industry Association

Perc Pineda, Ph.D., Chief  
Economist of PLASTICS

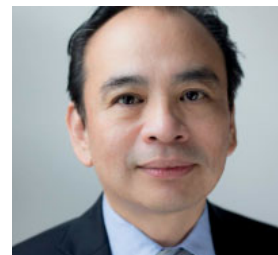

■ “Time flies when you’re having fun. And this year went fast. But I’m not sure if it was all fun for the US plastics industry in 2021. After all, the plastics industry continues to face challenges from the pandemic. As the year closes in a few days, the U.S. plastics industry performance in 2021 can be summarized in seven charts.

## Industrial Production of Plastics Products Manufacturing

Low plastics material and resins supply caused the plastics product manufacturing to slow earlier this year but turned around after May. Although resin production has increased, the plastics industry continues to face labor shortages. However, it appears that plastics production has been running on high gear to meet higher demand for plastics and plastic products. In November, plastics production was up 7.1% from a year earlier. Compared to the end of the COVID-19 recession in April 2020, plastics products manufacturing rose 23.0%. With 2021 expected to end on a high note, a 4.5% increase in plastics production can be expected in December year-on-year.

## Plastics and Rubber Shipments

Plastics and rubber shipments have been increasing since February this year. It increased 7.5% in October from a year earlier to \$22,019 million, according to the latest estimates of the U.S. Census Bureau. Business conditions remained favorable in November and assuming that’s unchanged in December, this year could close with shipments 9.5% higher than December last year.

## Plastics Manufacturing Employment

The US plastics industry continued to experience low labor supply in 2021 – reflecting the economy’s labor participation rate that appears to be stuck around 61.0% since June last year. Plastics products manufacturing saw an increase in employees in August reaching 598.6 thousand. The US Bureau of Labor Statistics estimates plastics manufacturing employees at 597.7 thousand in October. Considering the low supply for workers, it is unlikely that hiring increased dramatically in November, albeit in November plastics and rubber unemployment was estimated by BLS at 1.5%. This means that November and December plastics manufacturing employment could be at 596.3 and 596.2 thousand, respectively.

## Molds for Plastics Trade

This year saw stable plastics molds exports. Except in February, where exports were \$39.9 million, plastics molds exports stayed above \$40.0 million through October. May and August exports at \$53.1 million and \$57.3 million, respectively. It is projected that the two remaining months of 2021 will continue to see exports above \$40.0 million. Molds exports in 2021 are less volatile than in 2020. However, the uneven pace of emergence between countries

from the pandemic could cause only moderate increases in molds exports in 2022.

## Producer Prices in Plastics Material and Resins Manufacturing

After many years of stable resin prices, 2021 saw prices climbed into double-digits due to ongoing interruption of the pandemic and adverse weather conditions that caused resin shortages. While the causes of resin shortages have been analyzed by many industry observers, strong demand for plastics and plastics products sustained elevated prices throughout 2021. However, data suggest that resin prices peaked in the summer months – price increases moderated thereafter, which is expected through December. It remains to be seen when prices will return to their pre-pandemic levels. Given that supply chain issues could remain unresolved – at least in H1-2022 – resin prices could remain elevated, but the rates of increase will continue to moderate as resin supply catches up with resin demand.

## Capacity Utilization in Plastics Material and Resins Manufacturing

The plastics material and resins manufacturing capacity utilization rates averaged 88.0% in 2019 and 2020. This year could see that rate to average lower, at 83.1%, as supply continues to adjust. While the pandemic affected capacity utilization, adverse weather had a larger negative impact on capacity utilization than the pandemic per se. There is ample room for plastics material and resin manufacturing utilization rate to expand, which could be expected in 2022.

## Plastics Machinery Imports

Although the US manufacturing sector continues to grapple with supply chain issues, 2021 is looking to be a banner year for US plastics machinery. Demand has been running hot – in primary machinery types and auxiliaries – as converters deal with higher demand. Helped by low-interest rates to finance equipment investment, low labor supply caused processors to enhance productivity through plastics equipment and auxiliaries. Data shows that plastics machinery imports have stayed stable in 2021 as equipment suppliers continue to service robust demand. In October, plastics machinery imports totaled \$305.5 million – a 15.0% increase from a year earlier. While imports could slow in November and December, the likely scenario is from plastics machinery imports to increase 13.2% from 2020.”

► The Plastics Industry Association (PLASTICS)  
plasticsindustry.org

## Line for Innovative Capacitor Films Installed

■ Peak Nano Films, a U.S.-based nanotechnology leader, recently commissioned a Davis-Standard cast film line for processing a breakthrough dielectric film for capacitor applications. With this new equipment, Peak Nano Films has moved into production to serve automotive, military, electrical grid, and industrial markets. This new nanolayered film represents the first major materials improvement for solid-state film capacitors in decades. Davis-Standard collaborated with Peak Nano’s team to validate the process and tailor cast film machinery based on the company’s unique product requirements.

“We have grown with Davis-Standard throughout this endeavor,” said Mike Hus, Peak Nano Film’s senior vice president of engineering. “Davis-Standard’s technical expertise enabled us to collaborate on new processes and define machinery features prior to purchase. We value Davis-Standard’s experience and systems-oriented approach in helping make this film a reality.”

Peak Nano Films’ modern dielectric film structure overcomes current technology challenges to provide longer capacitor life, higher temperature resistance, greater breakdown strength, and a smaller footprint for capacitor designs. This includes two to four times the energy storage and temperatures up to 150 degrees Celsius (300 degrees Fahrenheit). As a result, capacitor producers benefit from additional design freedom and the potential for reducing systems costs for end-users.

According to Chris Oseredczuk, senior production engineer at Peak Nano Films, the Davis-Standard line is performing well. “We are highly satisfied with the line’s performance and Davis-Standard’s ongoing support. Their sales, techni-

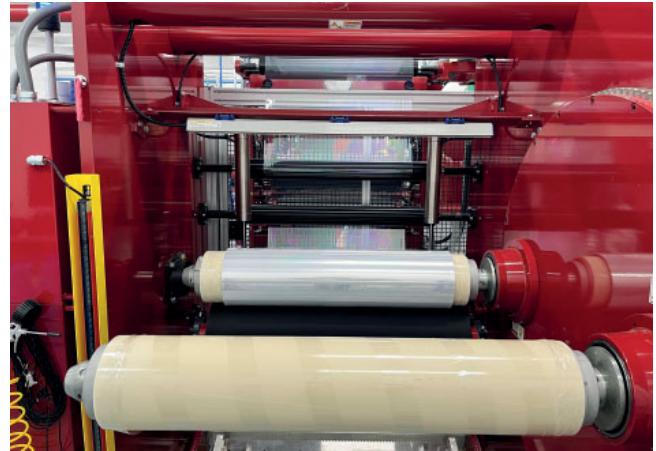

Peak Nano, film on turret winder

cal, parts, and field service teams have provided a timely response during all phases, including initial engagement and acceptance.”

Davis-Standard’s web handling expertise and scrap reduction strategies have been pivotal in helping Peak Nano Films deliver this film and other innovative products. In addition, a custom feedscrew design built specifically to adapt to the process requirements for this dielectric film has also been advantageous.

■ **Davis-Standard, LLC**  
[https://davis-standard.com/converting\\_system/cast-film/](https://davis-standard.com/converting_system/cast-film/)

**Peak Nano Films**  
[www.peaknano.com](http://www.peaknano.com)

## Appointment as Chief Operating Officer Announced

■ Muller Technology Colorado Inc., a leading global supplier of molds and automation solutions for sustainable thin-wall packaging, has named Thom Mandl as its new Chief Operating Officer (COO), effective January 1. The appointment was announced by Thomas Federer, Group CEO of Muller Technology.

Mandl, based in Fort Collins, will oversee day-to-day business operations and direct efforts to expand Muller’s growth strategy in the packaging industry.

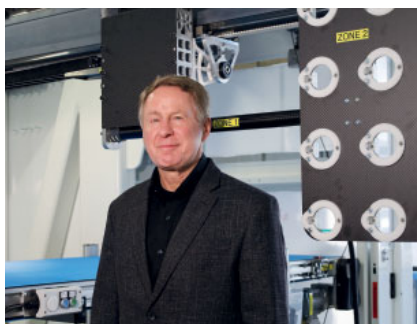

Thom Mandl

“Muller Technology is thrilled to have Thom join our team and help us manage and direct our business operations through an exciting period of emerging growth,” said Federer. “Thom’s skills, experience, and values make him a great fit with Muller Technology CO, and we are excited about the impact he will make moving our company forward.”

Mandl is a seasoned operations executive with over 25 years of experience in manufacturing. He has held leadership roles in production, engineering, quality, continuous improvement, and, more recently, general management.

“I am excited to join this outstanding and highly respected organization which is at the forefront of leading-edge technology for the plastics industry,” said Mandl. “I look forward to working closely with our highly talented staff to elevate our operational performance, quality control, and supply chain management, while delivering exceptional customer value.”

■ **Muller Technology Colorado Inc.**  
[www.muller-technology.com](http://www.muller-technology.com)

## Multiuse XP Express® – AGT Roll Stand Introduced

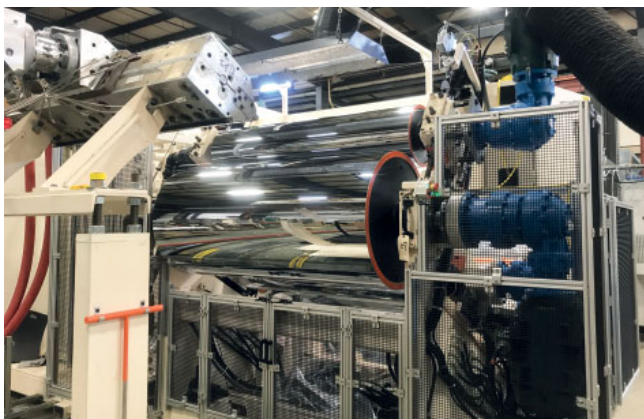

The new XP Express® – AGT rollstand for extrusion sheet and cast applications

■ Davis-Standard announces the introduction of the XP Express® – AGT (Active Gravity Touch) roll stand for both sheet and cast extrusion. As the latest addition to Davis-Standard's XP Express® roll stand portfolio, the AGT model features greater automation and process control for the full range of sheet (nominal 8 to 60 mil) applications. Processors benefit from technical and bottom line advantages of the roll stand's inverted-down, multi-roll design. This unique arrangement facilitates improved die nip management and handling, efficient web cooling and conditioning capabilities, precision roll drive control, and high-performance web path options. In addition, the XP Express® AGT addresses low melt strength resin delivery

from die slot to nip, and expands the processing of thin gauge sheet.

"The XP Express® – AGT is our most versatile and operator-friendly roll stand model yet," explained Steve DeAngelis, Davis-Standard's Vice President of Sheet and Foam. "It builds upon the sustained success of our existing product line to offer more automation and roll control along with smarter ergonomics and a space-saving footprint. This design is also engineered for both sheet and cast extrusion to give processors flexibility to support more applications, especially in rigid and flexible packaging."

The XP Express® – AGT is currently available in widths from 36 to 80 inches (900 to 2,000mm) and with process rates up to 5,500 pounds per hour. Processors can choose among three AGT roll stand options depending on specific requirements. Each option offers a fully automated multi-roll gap nip, individual roll speed and temperature control, enhanced heat transfer, and an adaptable pull-roll design. This is augmented by four-point Y-axis and traverse X-axis control to further support operator functionality. In addition, uniform cooling on both sides, double polishing capabilities, reduced web stress, and consistent web orientation and thickness control promote high-quality flat sheets with desired clarity.

Processors can integrate this rollstand into an existing line or collaborate with Davis-Standard to engineer a solution that addresses current and future operational goals.

■ Davis-Standard, LLC  
[www.davis-standard.com/extrusion\\_system/sheet/](http://www.davis-standard.com/extrusion_system/sheet/)

## New Chief Financial Officer Appointed

■ SI Group, a leading performance additives company, announced the appointment of Rustom Jilla as its Senior Vice President and Chief Financial Officer, effective immediately. Jilla succeeds Patrick Weinberg, who previously held the CFO position with SI Group. Jilla comes to SI Group with nearly 20 years of experience as the CFO of public and private equity-backed global manufacturing and distribution businesses.

Jilla will be responsible for overseeing SI Group's global financial operations, including finance, accounting, treasury, financial planning and analysis, and tax.

"Rustom is a seasoned executive with extensive international experience, financial expertise, and outstanding leadership qualities," said David Bradley, President and CEO at SI Group. "I am confident that Rustom will lead our global financial capabilities in a way that drives long-term, sustainable value creation opportunities for our stakeholders."

"I am excited to join the leadership team at SI Group, and especially at a time when the company is rapidly evolving,"

Rustom Jilla



commented Jilla. "SI Group is poised for growth in performance additives, and I look forward to helping deliver the company's operational and financial commitments in alignment with our strategy."

■ SI Group  
[www.siigroup.com](http://www.siigroup.com)

# New President in the US Appointed

■ KraussMaffei has appointed Nolan Strall as the new President of KraussMaffei Corporation North America (KMC), effective January 1, 2022. He will report directly to Volker Nilles, Executive Vice President New Machines. Previously, Nolan Strall served as Vice President of Operations and Digital & Service Solutions (DSS) for KMC. In this role, he was responsible for aligning the New Machines & DSS teams and processes to ensure maximum efficiency and profitability for the organization. In his new role, he will remain a member of the Digital & Service Solutions global management team.



Nolan Strall

Nolan Strall, Präsident der KraussMaffei Corporation North America (KMC): "I look forward to contributing to KraussMaffei's positive development, especially in terms of growth in new markets and technology diversification." "KraussMaffei looks back on more than 180 years of innovation and technology history, which led me to join the U.S. team at KraussMaffei Corporation in January 2020. In what has been a very difficult year for the industry and one of the largest organizational changes in the company's history, I found at KraussMaffei Corporation an amazing group of dedicated employees that we have now galvanized as one strong team for the future", says Strall. "The team we are building here in Florence, Kentucky, has a deep knowledge of our core technologies. We also have added key leaders and started initiatives in complementary technologies that will provide new solutions for our customers and enable us to enter new markets. I am honored to provide strategic and operational support and leadership to the team in North America as President. I look forward to contributing to KraussMaffei's positive development, especially in terms of growth in new markets and technology diversification", he adds.

KraussMaffei  
www.kraussmaffei.com

## SMART EXTRUSION

The only website collecting information about smart technologies of extrusion

34 600 + average monthly visits

Geographic distribution of Smart\_Extrusion readers, %

- Germany
- Austria and Switzerland
- Italy
- Eastern Europe
- Benelux countries
- Scandinavia

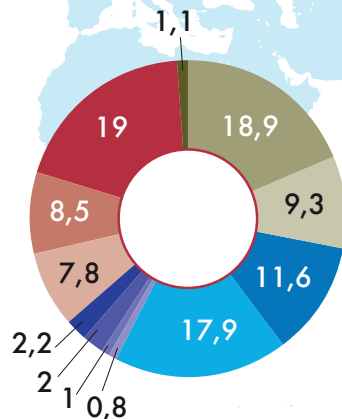

- Other
- Asia
- Russia
- South America
- North America
- Other Europe

# Design and Manufacture of Extrusion Tooling for Numerous Applications – and Uncompromising Service

*Guill Tool is a global leader in the design, manufacture and assembly of extrusion tools and related equipment such as die carts and striping machines. Having started in 1962, Guill has grown over the years to provide the extrusion industry a very wide assortment of products. As the company says in their advertising campaign currently, from the simple to the sublime, meaning Guill offers every type of extrusion head, from the Bullet and single concentricity models for profiles and single layer extrusions, up to the multi-layer, multi-material dies and the newest creation, the reciprocal medical tubing die, unique in the industry, which actually varies the chamber configuration in-process and is used for wound draining and other purposes in the medical/surgical market*

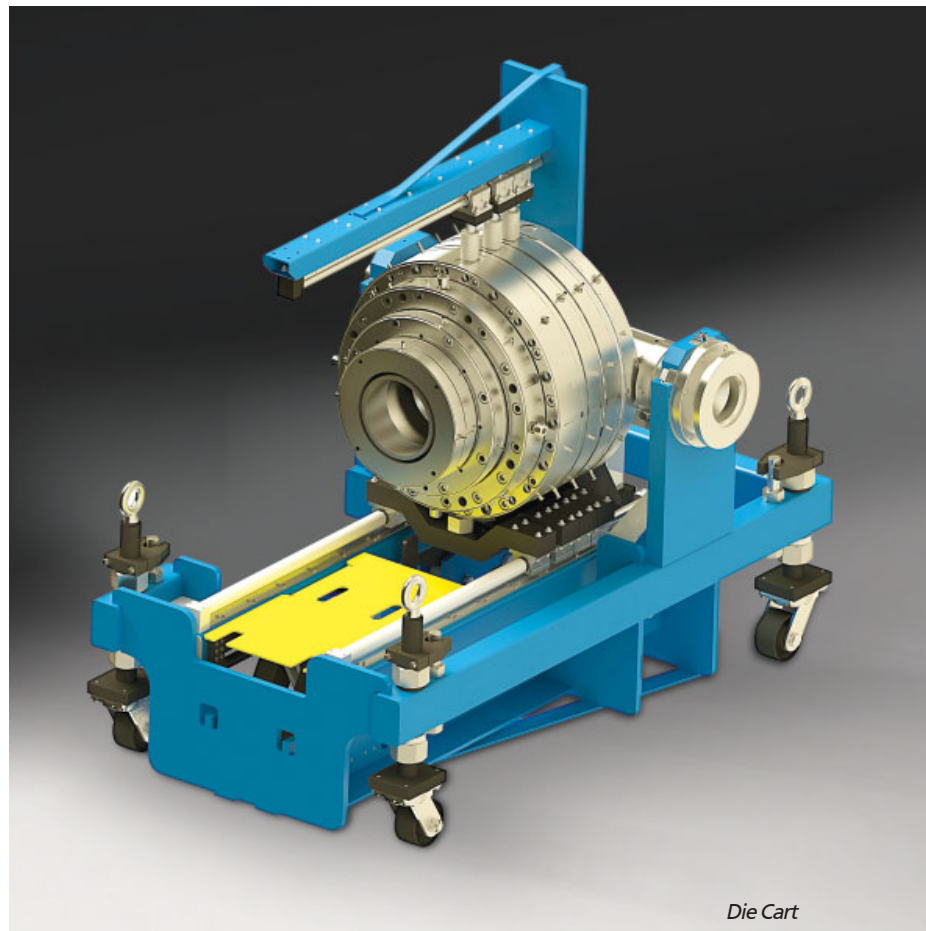

Die Cart

## Commitment

The Guill team is committed to producing quality extrusion tooling with uncompromising service. Customer satisfaction and customer success are Guill's most important concerns as products proceed through design and engineering to manufacturing, quality testing, shipping and installation with extrusion technical support, available from Guill on a global basis, through the substantial network of field representatives and technical experts.

## Experience

With more than 55 years of experience, we are recognized as the extrusion technology leader in the design and manufacture of extrusion tooling for numerous applications including medical tube, multi-lumen and multi-layer, profile products and fiber optics. Also included is extrusion tooling for automotive hose & tube, industrial hose & tube, pipe, blow molding, blown film, food, packaging, pelletizing, rubber & silicone, wire & cable, and wood composite.

## Products

Guill offers inline heads, crossheads, NoLeak water cooled heads, industry standard and custom tips & dies as well as spiderless inline tips & dies. The line of accessories and components includes cartridge heater systems, sizing dies, forming rolls, breaker plates, flanges, swing gates, special equipment and custom applications. The company has organized our extrusion tooling into Series designations to help customers find the best solutions for their process. Each



Series addresses a specific manufacturing process required by a wide range of industries throughout the world. With the flexible product design, any extruder configuration may be quickly and easily adapted. Over the years, Guill has partnered with leaders in extruder technology, resulting in a worldwide reputation for quality and reliability.

In addition, easy and fast cleaning are important benefits of Guill extrusion tools with specific instruction manuals provided with each extrusion head.

**Design**

Utilizing the latest 3D CAD/MCAD connected with FEA (Finite Element Analysis) and CDF (Computational Fluid Dynamics) Systems, Guill engineers were first to develop the FlexiSpiral™ deflector, the patented FeatherTouch™ die adjusting system for 100% concentricity control and the SealRight™ feature. The company has also developed a Quick-Change Manifold for rapid change of color and/or material, saving extruders considerable time and money during changeover procedures.

**Manufacturing**

With a full complement of EDM and 5-axis machining centers, Guill is unmatched in the manufacture of extrusion tooling. Combined with the in-house rheology lab, where materials are tested for performance and extrudability and extrusion processes are tested and run in full simulation, the Guill tools and equipment we of-

fer are fully documented to deliver the results needed. As further evidence of the quality manufacturing, Guill is known as a top supplier of medical and aerospace components through our sister divisions at the company.

**Industries Served**

Among the dozens of extrusion end markets Guill serves around the world: Blow Molding; Chemical Hose & Tubing; Compounding; Construction; Consumer Products; Corrugated Hose & Pipe; Cosmetics; Electronics; Energy; Fiber Optic; Food Processing; Industrial Hose & Tube; Industrial Pipe; Irrigation Tubing; Medical; Pelletizing; Pharmaceutical; Profiles; Rubber & Silicones; TPE and Specialty Compounds; Special Packaging; Under Sea Cable & Pipe; Utilities; Universities; R&D; Wire & Cable; Wood & Composites.

**Useful Tools**

A little known fact about the Guill website, the company offers various calculators to help extruders. These tools are very useful in determining:

- DDR to Tooling
- Tooling to DDR
- Extrusion Rate Calculator
- Annual Cost of Lengthy Concentricity Adjustments
- Crosshead Replacement Analysis

**Latest Achievements**

Guill has released its new reciprocating head. The traditional tip and die assembly is replaced with a linear reciprocating assembly that chang-

es the tube's profile within a given length. This process is repeated throughout a single extrusion run without interruptions. Cutting capability, in association with the extrusion speed, cuts the finished product to length.

While cost and value stream activities are reduced, quality is improved. Only one extrusion run is needed to produce a finished product, as opposed to multiple extrusion runs with tooling changes along with a manual assembly operation to connect different tubing shapes. Guill's new reciprocating head eliminates an assembly operation. It also eliminates in-process inventory. Thus, there is no need for storage of various tubing shapes and connectors needed for assembly, fulfillment of orders and replenishment of finished goods.

Furthermore, the reciprocating head eliminates a connecting piece, allows JIT production and products made-to-order. Lastly, it reduces total run time from receiving the order to shipping.

Furthermore Guill announces the immediate availability of its new die cart with easy disassembly and reassembly. It features a high volume, adjustable center accumulating crosshead. This crosshead is designed to produce a smooth linear bore and provide jacketing over various substrates. The crosshead's maximum thru core is 18," while its maximum die ID is 23". Built to handle thermo-plastic applications, the crosshead includes tooling and isolation sleeve design. Additionally, the tooling section features quadrant heating. Guill's crosshead stand is equipped with an integral alignment station and concentric role guide. The stand is also an integral cleaning station, so clients don't need to remove the crosshead for cleaning. Lastly, this crosshead has "on-the fly" catenary adjustment and can be easily maintained with simple hand tools.

*Reciprocal Tubing Die produces changing internal profiles without the need for section assembly*

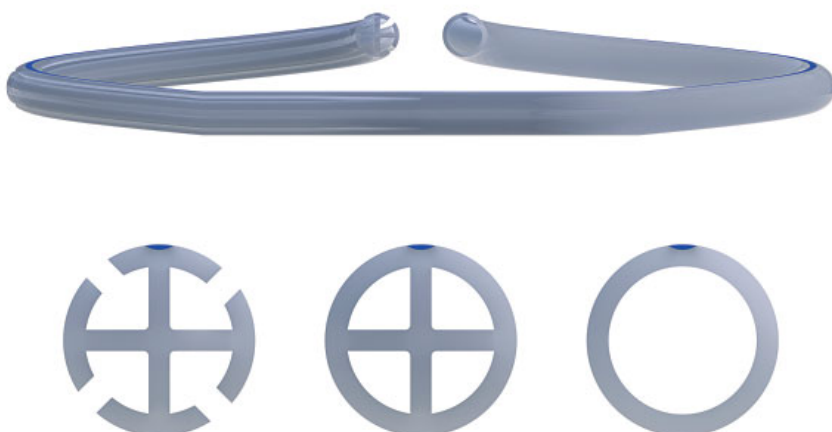

As the demand for recycled plastics grows, so does the size of the machines. This applies to the processing of polyolefins as well as to PET recycling. With its unique dimensions and production capacity, this new size of plant features a screw diameter of 280 mm, implemented for the first time in a VACUREMA® Basic 2628 T large-scale project for producing rPET pellets. EREMA has just shipped the plant to a customer in Brazil



The reactor of the VACUREMA® T large-scale plant, which will go into operation in Brazil, almost reaches the roof of the new production hall, which was commissioned in 2021.

## New Dimension with Large-Scale Recycling Plants

Up to 40,000 tonnes per year of rPET meeting the highest quality standards can now be produced. "For this purpose, we installed a screw with a length of 10 me-

*From the Left: Patrick Rachinger, Product Group Manager, and Sophie Pachner, R&D Engineer (Photo: EREMA GmbH)*



ters, a diameter of 280 millimetres and a weight of 3.5 tonnes, which is the largest ever used in one of our recycling machines," explains Managing Director Michael Heitzinger. The screw was manufactured by 3S, a subsidiary of EREMA. No less impressive is the reactor of this recycling system, which, with a height of around 10 metres, is also unique and almost reaches the roof of the new production hall. 500 tonnes of input material were recycled during the test phase, which was subject to strict quality control. "The entire project was a great team effort," Heitzinger said, thanking everyone involved.

Just four years ago, the largest extrusion line supplied by EREMA was designed for a throughput of 15,000 tonnes per year. This size of plant was ordered by customers once or twice a year. In the meantime, machines like this leave the production site in Ansfelden every month. As early as 2020, EREMA proved to be a pioneer and reliable partner for implementing unique large-scale projects. That was when the food and beverage packaging manufacturer Envasas Universales Mexico commissioned two VACUREMA® Basic 2625 T machines, each with a screw diameter of 250 mm and a capacity of 30,000 tonnes per year.

EREMA Engineering Recycling Maschinen und Anlagen GmbH  
Unterfeldstr. 3, 4052 Ansfelden, Austria  
[www.erema.com](http://www.erema.com)

VM VERLAG GmbH  
EXTRUSION

Organized by  
Extrusion magazine

Пластик Пластик magazine



interplastica show

March 16, 2022

Online

10:00 AM (UTC+03:00)

Official language: Russian

• 2nd International Conference •

# Laboratory & QC Russia

Laboratory and quality control  
in polymer processing company

## Conference key topics:

- Modern laboratory and measuring equipment
- Incoming materials and final products quality control
- Plastics processing simulation software
- Inline control
- Pilot and testing lines
- Desktop mini IMM and mini extruders, laboratory mixers
- Lab testing, formulation development and certification services
- Engineering and research services
- R&D activities in the manufacturing company

## Contact

Alla Kravets

+49 2233 949 87 93

a.kravets@vm-verlag.com

**lab-rus.extrusion-info.com**

Learn more:



# Mixed Waste Sorting Changing the Game

*TOMRA and a Norwegian waste sorting plant have demonstrated that mixed waste sorting prior to disposal is a superior solution to separate collection. Since it stopped the separate collection for plastics in its region and unleashed the power of mixed waste sorting, the facility increased recovery rates from 28% to 82% and achieved recycling rates of 56,4%, thus meeting the EU's 2025 recycling targets ahead of time. Today, IVAR ranks first in processing MSW by volume*



Situated in Forus, between the cities of Stavanger and Sandnes in the southwest of Norway, IVAR manages all residues and waste collection from 10 municipalities with an approximate population of 325.000. With its advanced municipal solid waste sorting plant, it recovers high volumes of recyclable materials be-

fore incineration, reducing CO<sub>2</sub> emissions and the global dependency on virgin material by supplying high-quality recycled content for new products and packaging. When local and international recycling targets became increasingly stringent, IVAR recognized the need to improve its waste management

methods and decided to more closely examine the hidden potential of its region's household waste. With the goal of finding the most effective and environmentally friendly approach to waste management, the company sought the advice of TOMRA. To identify the opportunities in mixed waste sorting and assess its performance potential, the plant sent MSW samples from the region to TOMRA's test facility in Germany. There, these materials underwent extensive tests on the company's sorting machines. Test analysis showed that, whereas paper recovery from MSW streams performed reasonably well, plastics recovery offered room for improvement. Test analysis unveiled that the household waste contained high amounts of plastic recyclables, even though they were meant to be disposed of separately. The team considered the analysis as a clear call for concrete, future-oriented action.

## **Embracing new opportunities**

Based on the analysis and the still untouched possibilities in MSW sorting, a new business case was developed.



The result: the construction of a new fully automated mixed waste sorting plant consisting of new facilities for plastics reprocessing and paper sorting, as well as the elimination of the separate plastics collection in that region. Previously collected separately, plastics are now also disposed of in the grey bin and recovered in the new facility. As a consequence, only the plant's residues are transported to the waste to energy plant and used for the production of electricity and energy for remote heating systems. In short, the materials discarded by the municipality are turned into value again in the most optimal way.

In late 2014, the plant building project began with Sutco Recycling Technik chosen as a plant supplier for IVAR's combined residual waste and paper sorting plant. Sutco, in turn, selected TOMRA Recycling as project partner for sorting equipment. Since the new facility started operation in January 2019, 22 of TOMRA's state-of-the-art AUTOSORT® sorting units efficiently and effectively sort plastics (PET, PS, LDPE, HDPE, PP) and paper (mixed paper, cardboard, beverage cartons) out of the residual waste (grey bins) collected curbside. In addition, metals (aluminum, steel) are recovered from the residual waste. "We have been delighted to be given the opportunity to consult with IVAR in the planning of the new plant,

provide our latest sensor-based sorting equipment and accompany such an exciting and game-changing project," comments Oliver Lambertz, TOMRA Recycling's Vice President and Head of Business Development. By combining the most advanced processes, plant equipment and sorting technologies, the waste sorting plant has set the following targets: sort nearly all PE, PP, PS or PET plastics suited for (mechanical) recycling; sort 95% of the fractions identified; and realize purity rates of 95 to 98%.

#### From mixed waste to recyclable mono fractions

The residual waste generated by the municipalities IVAR serves contains a large amount of valuable and recyclable materials, which in their purest and homogenous form, can be further processed, recycled, and reintroduced into the market as high-quality recyclates. Today, IVAR processes 40 tons of MSW per hour from which paper, plastics, metals, and residues are separated in numerous steps:

#### Presorting

Once the collected material is fed into the plant, items > 350mm are sorted by a finger screen and shredded into smaller pieces before two drum screens separate the material into three target sizes: 0-60mm; 60-150mm; and 150-320mm. In a sec-

ond step, TOMRA's AUTOSORT machines recover 90% of the mid-sized (60-150 mm) and the large (150-320 mm) plastic fractions before they extract mixed paper. Finally, magnets and eddy currents remove both the non-ferrous and ferrous metals.

#### Plastics and paper recovery

After plastics have been presorted, they are further sorted by material type. First, ballistic separators separate plastic film and rigid plastics. Afterwards, 14 AUTOSORT® machines undertake the separation of rigid plastics into PP, HDPE, PS, PET and create a clean fraction of LDPE plastic film. To further increase purity levels, these clean material fractions undergo a second sorting step, also carried out by AUTOSORT® machines, to remove the remaining contaminants. The high-quality PS and PET end fractions are then packed into material-type-specific bales and sent to different mechanical recycling plants in Europe. LDPE, HDPE and PP are washed, dried and pelletized in the Forus plant and sold as pellets.

When starting operations in 2019, IVAR set an overall goal to recover nearly all plastic types (PE, PP, PS, PET) and a more concrete target to realize purity rates of 95 to 96% in LDPE, PP, HDPE, PS and PET sorting. Thanks to the ultraprecise sorting machines, the plant's goal soon became reality, with purity rates of up to 98% achieved. As for paper, sorting studies have shown that more than 85% of all beverage cartons in the residual household waste have been successfully separated from the household waste stream.

#### A new life for plastics

After extraction of recyclables from the infeed material, the sorted fractions undergo an extensive recycling process on-site. Whereas homogenous PET and PS bales as well as both ferrous and non-ferrous metals are sold to European recyclers, Polyolefins (LDPE, HDPE, and PP) are shredded into flakes, hot washed, dried and pelletized on-site before these are sold as industrial commodities. Thousands of tons of PE and PP recovered from MSW have been di-





verted from incineration and to be integrated in the production of high-quality PO recyclates.

**Cutting down environmental impact**

The business case at IVAR proves that sorting prior to disposal can preserve recyclable materials previously incinerated and strongly contribute to climate protection. Prior to opening the waste sorting plant, the separate

collection rate in the region served by IVAR was high: 65% of the waste collected in the municipalities was sorted. However, with the plant fully operational, the recovery rates of recyclables are now as high as 74%. From an environmental perspective, sorting, recovering, and recycling plastics from mixed waste streams – instead of relying solely on material-dedicated collection systems – leads to a two-fold reduction in CO<sub>2</sub> emissions. First, less plastics, that comes with a high caloric value but based on fossil carbon, are incinerated. Second, the provision of high-quality recycled plastics reduces the need for primary production. Thus, IVAR contributes to delivering environment-friendly feed and works in line with the principles of a circular economy, resulting in a decrease of 33,000 metric tons of CO<sub>2</sub> emissions a year, which is equivalent to taking 20,000 fossil fuel cars off the road.

**Looking back and beyond**

The results have clearly shown that MSW sorting before incineration brings numerous benefits: in Norway, the need for separate collec-

tion of plastics packaging, and its associated costs, has been eliminated and enabled IVAR to provide ready-for-market recycled material for new products and packaging, while reducing its CO<sub>2</sub> footprint considerably. Furthermore, the partners have already started to investigate if glass and biowaste could be profitably extracted from the fines fraction (0-60 mm).

Automating the sorting process with the latest technology has strongly contributed to this change. However, the partners are convinced that automation only complements waste sorting but will never replace local separate waste collection systems. Rather, the components of optimal waste management must go hand in hand – from collection to mixed waste sorting to recycling – to have the biggest impact on how much we recycle.

■ TOMRA Sorting GmbH  
 Otto-Hahn-Str. 2-6,  
 56218 Mülheim-Kärlich, Germany  
[www.TOMRA.com/recycling](http://www.TOMRA.com/recycling)

# SMART EXTRUSION

The only website collecting information about smart technologies of extrusion

**34 600 + average monthly visits**

Geographic distribution of Smart\_Extrusion readers, %

- Germany
- Austria and Switzerland
- Italy
- Eastern Europe
- Benelux countries
- Scandinavia

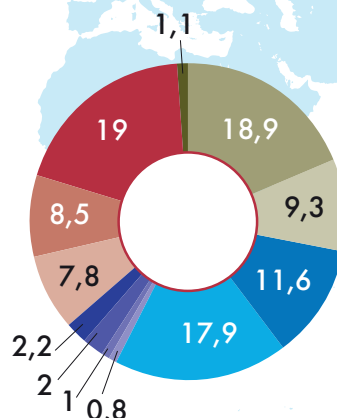

- Other
- Asia
- Russia
- South America
- North America
- Other Europe

## Organizers:

The Extrusion magazine  
(VM Verlag GmbH)

**EXTRUSION**  
VM VERLAG GmbH

The Plastiks magazine:  
plastics processing industry

**Пластик**



Supported by the interplastica show  
(Messe Duesseldorf Moscow)

# converting Russia

One-day online conference

June 29, 2022

The beginning

will be at 10:00 AM (UTC+03:00)

Official language: Russian

The Converting Russia conference is focusing on the up-to-date processing techniques for thin-sheet polymer materials: films, sheets and nonwovens (most of them are being rolled). Converting technologies are demanded by a broad spectrum of industries: production of packaging, toiletry, furniture, nonwovens and electronic devices, printing trade, machine building, chemicals sector, automobile manufacturing, aerospace, food processing, pharmaceuticals, medical, agriculture, building and construction.

### Conference key topics:

- ⇒ coating technologies
- ⇒ solvent and non solvent lamination
- ⇒ slitting and winding
- ⇒ special pretreatment
- ⇒ flexographic and rotogravure printing
- ⇒ film extrusion
- ⇒ materials and semi-finished products
- ⇒ equipment modernization
- ⇒ industrial process control
- ⇒ process automation
- ⇒ laboratory equipment, materials and finished products quality control
- ⇒ waste recycling

### Contacts

Alla Kravets

+49 2233 949 87 93

a.kravets@vm-verlag.com

Learn more



[converting.extrusion-info.com](https://converting.extrusion-info.com)

# Recycling Company in United Kingdom Processes ASR Fractions and Electronic Scrap Using the Rotorshredder from Germany



*The recycling plant in the UK for processing automotive shredder residue (ASR) and electric and electronic scrap (WEEE) was still under construction here. It was planned and implemented by BHS-Sonthofen (©CMüller)*

*British recycling specialists Recycling Lives commissioned a recycling plant that was planned and implemented by BHS-Sonthofen. The plant is designed to handle a variety of materials such as automotive shredder residue (ASR), electric and electronic scrap (WEEE) as well as so-called "meatballs" (electric motors and motor armatures). The process developed together with the company is based on a profitability analysis and ensures marketable end products*



In the process of expanding capacities, the British recycling company Recycling Lives decided it required a plant that could process different materials simultaneously at its 15-acre Recycling Park in Preston. These included ASR, waste electrical and electronic equipment (WEEE), metal composites and meatballs. After BHS had drawn up an initial concept for a plant, extensive tests were carried out at the Sonthofen, Germany, test center with about two to three metric tons of each material required by the customer.

**BHS calculated profitability after tests in the test center**

Customers of BHS-Sonthofen need a validated basis for decision-making before they invest in a new plant. Data on throughput and material quality, among other parameters, is collected during the tests and analyses in the test center. This information is then used to create a mass balance a profitability analysis – a key advantage for customers. The recycling company used the calculation to estimate the profitability of the plant investment.”

Accordingly, the experts from BHS designed the plant based on the test data. The feed material is supplied to the Rotorshredder of type RS 3218 via a feeder. The tools of the Rotorshredder exert a very intense stress on the feed material through impact, shock and shearing forces.



*The process developed together with the company is based on a profitability analysis*

The result is selective size shredding: Particle sizes are selectively reduced and composite materials are separated. All fine fractions of particle sizes smaller than 25 mm are processed on other existing plants. The fraction >25 mm is conveyed to a zigzag sifter, which frees the feed material from light material (fluff, films, fibers, dust, etc.).

The cleaned material is then transported via an overhead magnet to a cyclone separator, which was included in the order to BHS. In the overall control concept BHS took these assemblies into account and also supplied the steel structures for these parts of the plant. The process, which

was developed by BHS together with the British customer, produces market-ready end products.

Recycling Lives’ Chief Engineer Gary Halpin explained: “Since the machine was installed three years ago downstream from our main shredder at the Recycling Park in Preston, it has proved efficient in further reducing the particulate size for more efficient extraction of metals and other materials from the waste stream. It is a valuable element within our waste processing operation, helping to extract maximum value and also increase the amount of material that can be recycled as we progress towards a circular economy solution.”

*The tools of the Rotorshredder exert a very intense stress on the feed material through impact, shock and shearing forces*

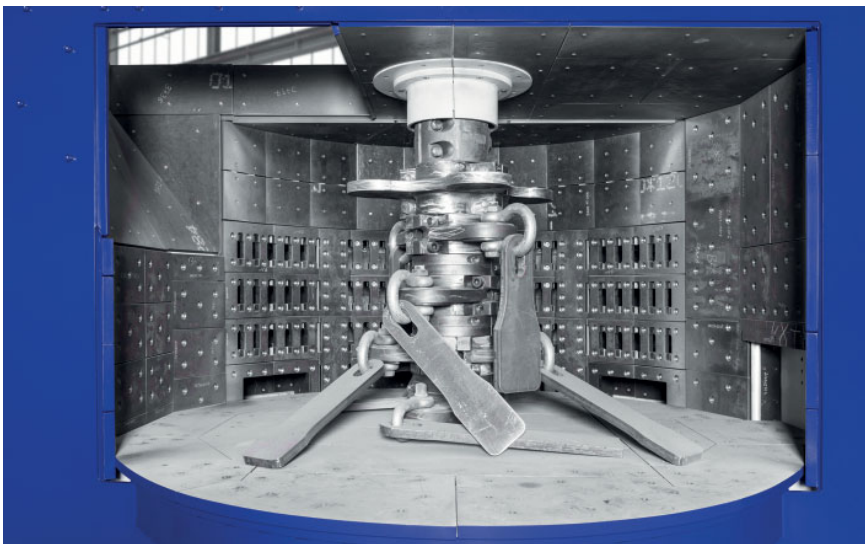

*The Rotorshredder of type RS 3218 is the centerpiece of the plant (©CMüller)*

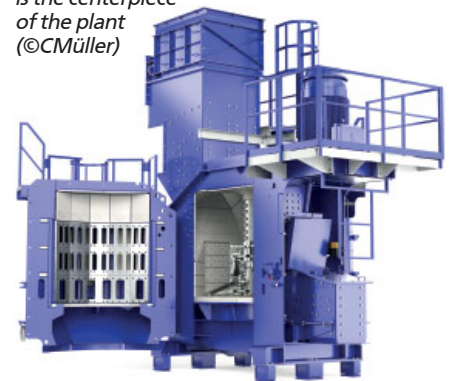

► BHS-Sonthofen GmbH  
An der Eisenschmelze 47,  
87527 Sonthofen, Germany  
[www.bhs-sonthofen.com/en/](http://www.bhs-sonthofen.com/en/)

Recycling Lives  
[www.recyclinglives.com](http://www.recyclinglives.com)

*PrintCYC provides important input for design for recycling guidelines*



## Research Evaluates the Impact of Printing Inks on Recyclability of Plastic Films

Printing inks have a major impact on the recyclability of plastic films, the recycling process, the quality of regranulates as well as their processability. The PrintCYC initiative started two years ago to investigate this impact more closely and drive circular economy. Today, the initiative is once again providing insights into its research work: Currently focusing on the impact of pigments on the recycling process, PrintCYC has found that standard pigments for flexo- and rotogravure printing show excellent compatibility with recycling and enable recyclates comparable to virgin film. This opens a wide range of reuse possibilities in different film and packaging applications.

The PrintCYC consortium was established in 2019 to support the transformation of printed polyolefine-based packaging films towards a circular economy by evidence-based industrial trials. Key stakeholders are leading machine manufacturers such as Brückner Maschinenbau, Erema, Kiefel and PackSYS Global, the printing ink manufacturer hubergroup Print Solutions, and Profol, one of the market leaders for PP cast films. The initiative is coordinated by Dr Annett Kaeding-Koppers, an independent packaging expert and sustainability consultant. PrintCYC is connected to converters and in continuous dialogue with brandowners, recyclers, and platforms such as Ceflex and Forum Rezyklat to discuss and share results.

In the starting phase of the project in 2019/2020, PrintCYC successfully produced PP and PE film and packaging samples containing more than 50 % of recyclate from post industrial sources. Focusing on the recyclability of the binders NC (nitrocellulose), PU (polyurethane) and PVB (polyvinylbutyral), the initiative identified the binder PU as most temperature resistant and, thus, as best recycling-ready solution for mechanical recycling without de-inking.

At the beginning of this year, PrintCYC started into the next project phase, investigating the impact of pigments on the recyclability of printed packaging films. Inorganic pigments

are mostly temperature stable and therefore supposed to be recyclable without degradation. However, organic azo-pigments like most standard red and yellow pigments are more temperature sensitive and might re-split into critical components. The pigments yellow (Pigment Yellow 17) and red (Pigment Red 57:1) are commercially available standard pigments for flexo- and rotogravure printing and were selected for the recycling trials.

Both pigment types showed excellent recyclability, leading to odour- and defect-free, colour-stable PP recyclates. The material properties of the coloured recyclates were analysed technically and analytically.

After the first recycling loop, PrintCYC found no significant impact on material properties compared to virgin reference. Based on a specific migration screening test, the renowned Swiss quality testing laboratory SQTS evaluated the PP recyclates according to the limits of the Commission Regulation (EU) No 10/2011 and Swiss Ordinance 823.023.21 on materials and articles in contact with food. The positive results open a wide range of reuse in different film and packaging applications.

For the next project phases, PrintCYC is looking for partners to test and evaluate closed loop printed PP packaging scenarios and to further improve relevant design for recycling guidelines.

*PrintCYC started in March 2019. The initiative was launched by a group of companies within the value chain of printed films. The acronym PrintCYC stands for printed polypropylene (PP) and polyethylene (PE) films for mechanical recycling.*

**AKK INNOVATION**  
Dr. Annett Kaeding-Koppers  
annett.kaeding@akk-innovation.de

Organized by

Extrusion magazine / VM Verlag

**EXTRUSION** **VM** VERLAG GmbH

smart\_molding website  
www.smart-molding.com

**smart\_molding**  
international

Plastiks magazine

**ПЛАСТИКС**

with support from  
the interplastica show



**March 15, 2022**

Online

10:00 AM (UTC+03:00)

Official language: Russian

• 2nd International Conference •

# Blow Molding & Caps

**Blown plastic products, and caps  
and closures manufacturing technologies**

## Key topics:

- Extrusion blow molding и injection blow molding technologies
- Injection molding of caps, closures, and preforms
- Blow molding tools and molds for caps, closures, and preforms
- Products decorating with IML process, tampon printing, and hot foil printing
- Tubes and pipes extrusion
- Process automation and robotization, IML-robots
- Peripheral and auxiliary equipment, air-preparation systems, cleanroom construction process
- Special materials and additives
- Polymer processing simulation software
- Special laboratory equipment

---

## Contact

**Alla Kravets**

+49 2233 949 87 93

a.kravets@vm-verlag.com

Learn more:



**[blow-molding.extrusion-info.com](http://blow-molding.extrusion-info.com)**

# New Recycling Options for Printed PP Films

*The research initiative PrintCYC, of which KIEFEL is a member, has gained further insights into promoting the circular economy of plastic packaging through material recycling. PU-based printing inks allowed the production of color-stable, odorless and defect-free recyclates from fully printed PP-based packaging films by mechanical material recycling, incorporated into flat films without any problems and deep-drawn on thermoforming machines from Kiefel with lower energy consumption. This will open up new possibilities for recycling post-industrial printed film waste and potential for zero-waste production along the value chain of PP-based packaging for packaging manufacturers*



*Deep-drawn cups and bowls with > 50% PP recycle, made from printed PP film (©KIEFEL GmbH)*

## Alternative to non-food packaging made from virgin material

Kiefel has successfully thermoformed both colored trays and cups from the recycled PP flat films, on the KMD and KTR series machines. "The machine settings practically did not have to be changed from processing of new material," emphasizes Olaf Tanner, Head of Project and Product Management in the Packaging division at Kiefel.

"The shape, appearance and functionality of the deep-drawn, recycled packaging is so good that it represents a real alternative to non-food packaging made from virgin material."

## Energy savings of up to 20%

In addition, with the increasing proportion of recycled material, savings of up to 20% in heating energy could be observed in the production of deep-drawn PP cups compared to virgin material. This effect can even be further enhanced through the use of dark recyclates due to the better heat absorption. "As a result, we can operate our machines with a shorter heating time," adds Tanner.

This opens up interesting possibilities for packaging manufacturers to reduce the proportion of new materials in their containers to contribute to the climate and to save energy.

## Production of recycled PP flat films

The recyclates have also been incorporated up to 100% into the middle layer of ABA flat film structures of different thicknesses (500 µm, 800 µm) without any issues. The use of extrusion technology, equipped with a single screw without degassing or a twin screw with degassing, has proven equally suitable for producing color films free of defects and odors with excellent thickness uniformity and stretchability.

PrintCYC is an initiative along the entire packaging value chain for the recycling of printed films. The consortium utilizes fact-based industrial tests to showcase solutions for a circular economy of printed PP-based packaging films. The initiative includes the machine suppliers Brückner Maschinenbau. Kiefel and PackSys Global, Profol, the specialist for flat films made of PP (polypropylene), the printing ink manufacturer hubergroup Print Solutions, and Erema, the specialist for recycling technology.

*Increased amounts of rPP reduce energy consumption in cup production (©PrintCYC)*

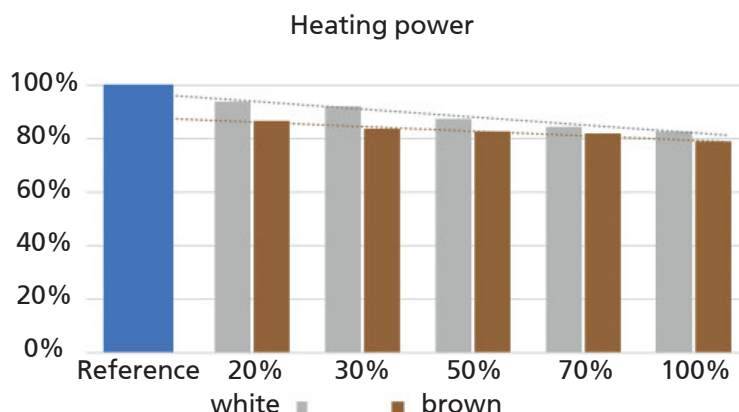

 KIEFEL GmbH  
 Sudetenstr. 3,  
 83395 Freilassing, Germany  
[www.kiefel.com](http://www.kiefel.com)

**300+**  
participants

Azimut hotel  
43/1, Lermontovsky prospect  
Saint-Petersburg  
Russia

May  
**17-18,**  
2022



**IPTF**



**10**

anniversary  
International Polymer  
Technology Forum

**W**orking in polymer  
company?

**THIS FORUM IS FOR YOU!**

⚙️ We look forward to meeting you at  
Fontanka River Near the Egyptian Bridge

- ▶ Extrusion
- ▶ Injection molding
- ▶ Laboratory
- ▶ Recycling
- ▶ Polymers and additives
- ▶ Films
- ▶ Profiles
- ▶ Pipes and tubes
- ▶ Smart warehousing
- ▶ Automation and peripherals



**C**omprehensive review of all the issues,  
vital for plastics processors

Contact

Alla Kravets

+49 2233 949 87 93

a.kravets@vm-verlag.com

Organized by

**VM** VERLAG GmbH

**EXTRUSION**

**ИНТЕРПЛАСТИКА**  
МЕЖДУНАРОДНОЕ ОБЩЕСТВО ПРОЦЕССОРОВ



Learn more at  
[iptf.extrusion-info.com](http://iptf.extrusion-info.com)



*As a medium-sized German machine construction business, BB Engineering has been manufacturing components and systems for synthetic fiber and film production for more than 20 years. For several years now, the company has been concentrating on recycling system development work. We discussed just how the seemingly different business units interact and how the recycling business profits from the existing extrusion and spinning systems know-how with Dr Klaus Schäfer, Managing Director, and Matthias Schmitz, Head of Engineering Recycling Technology*



*Matthias Schmitz, Head of Engineering Recycling Technology (left) and Dr Klaus Schäfer, Managing Director of BB Engineering GmbH (right)*

# How Spinning and Recycling Go Together

*Dr Schäfer, BB Engineering has its origins in the manufacture of extrusion and filtration systems for synthetic fiber spinning equipment. How did you come to open a new business unit dedicated to PET recycling?*

**Dr Klaus Schäfer:** You are fundamentally right. Our original business

was, and remains, focused on components such as extruders and filters for processing the most diverse polymers into synthetic fibers, but also into films and on developing and distributing other products. Soon, our portfolio was complemented by our own compact spinning system – in

the form of the VarioFil. Our extruder and filters have also been used for rPET for many years now. We first supplied components for rPET back in 2005. For these reasons, PET recycling was not something completely new to us. In 2012, we unveiled the VarioFil type 'R', which also spins rPET granulate into high-end yarn. And, in 2016, we went a step further with the type 'R+': the direct processing of bottle flakes using our compact spinning system – in other words, recycling and spinning in a single step. The background to this was to dispense with the intermediate step of producing the granulate, hence saving lots of energy and cutting conversion costs, and to create high-quality POY from bottle flakes.

*What potential benefits do you see in the recycling of synthetic fibers?*

**Dr Schäfer:** Apart from the social responsibility of acting in a resource- and environmentally-friendly manner, we believe that recycling fibers presents our customers with considerable commercial opportunities. Firstly, there is production waste. Despite spinning technology becoming

*Matthias Schmitz and Dr Klaus Schäfer by the VacuFil test system at the company HQ in Remscheid*



ever better, there is always waste in the form of B-quality goods, caused by over-production and during start-up and retooling. Instead of simply disposing of this – in view of constantly rising prices for raw materials and decreasing availability – nevertheless valuable material, it is far more economical to process it and return it to the production process. Yarn manufacturers can not only cut costs, they also become more autonomous. Furthermore, general developments, such as increasing population densities and fast fashion, are creating ever greater demand for polyester and polyester fibers. Here, many major textiles manufacturers have set themselves ambitious targets with regards to the utilization of recycled fibers. So, you can now see that the potential benefits of fiber recycling are tremendous.

*So, VarioFil R/R+ was a huge milestone for BB Engineering. You are now expanding your portfolio with the VacuFil. What exactly is the VacuFil and how does this system differ from the VarioFil R/R+?*

**Matthias Schmitz:** The starting point for the VacuFil was the aim of offering our clientèle a zero-waste spinning system with which they can reutilize their own production waste. Very much in line with the circular economy. The VacuFil recycles this waste. The VarioFil then spins the processed material. Whereby the VacuFil stands on its own, of course, and can also be combined with a granulation process and other further processing procedures. Equally, starting materials other than spinning waste can be processed as well – such as

*The VacuFil test system at the company HQ in Remscheid is available for customers and interested parties for material and process testing*



bottle waste, trays, films, etc. On the one hand, these of course have completely different properties and, on the other hand, the requirements of the subsequent recycled material also vary depending on the end use. To ensure the VacuFil is able to fulfill such changing recycling tasks in a reliable and reproducible manner, the flexible controlling of the intrinsic viscosity was the top priority during development.

*Where do you acquire your know-how? Processing virgin material into films and filaments and recycling polyester are actually two completely different processes.*

**Dr Schäfer:** Of course, these are two completely different processes, but we view the necessary conversion into recycled material from perspective of the end product. The desired properties of the end product determine the requisite quality of the starting material and hence also the requirements for the recycled materials and their production. We come full circle. Hence, we know precisely what is important when recycling PET to ensure that further processors are able to use it to create high-quality products.

*In theory, that sounds very promising. What does the performance look like in practice?*

**Schmitz:** Our trials have shown that – in the right configuration – our high-end extrusion and, above all, our filtration technologies are able to produce high-end rPET granulate for high-quality POY or FDY. Our system creates an intrinsic-viscosity build-up of up to 0.15 dl/g and homogeneity fluctuations of just  $\pm 0.01$  dl/g. We have achieved outstanding results in our tests. In part, the recycled materials from our VacuFil systems even offer superior spinning properties compared to the virgin material used in the tests – particularly with regards to spinning breaks and lint formation. We offer our test system to customers and other interested parties for specific material and process tests.

*These are surprisingly positive results, considering you normally have*

*to accept compromises when using recycled materials. How have you achieved this? What is so special about the VacuFil process?*

**Schmitz:** Fundamentally, we use liquid-state polycondensation, which cleans more effectively than solid-state polycondensation processes. But the truly special feature with the VacuFil is, above all, our Visco+ component. With this, we have developed a unique vacuum filter system for viscosity build-up and viscosity homogenization. We currently have a patent pending here. Add to this the interaction with high-end extrusion, large-area filtration and the excellent degasification technology.

**Dr Schäfer:** The right configuration of these units is absolutely decisive. We are proud that we have succeeded here, drawing on our many years of extrusion and filtration expertise.

*Mr Schmitz, you mentioned that the VacuFil is compatible with various further processing procedures. What possibilities do manufacturers actually have?*

**Schmitz:** You can combine the VacuFil with various pelleting units. However, you can also feed the recycled melt from the VacuFil directly into the further processing systems, regardless of whether these are spinning systems, film production units or other manufacturing processes. There are many possible options. BB Engineering also offers several optional add-ons for the VacuFil. For example, our 3DD mixing system, which enables the recycled material to be returned to the virgin polymer flow in a polycondensation system. This mixing system can also be used to add additives, masterbatches and similar to the rPET melt. Overall, the VacuFil is extremely modular and flexible.

*A really exciting system. We wish you continued success and thank you for talking to us!*

BB Engineering GmbH  
Leverkuser Str. 65  
42897 Remscheid, Germany  
[www.bbeng.de](http://www.bbeng.de)

# Mission Circular Economy – *High-performance full PE films through MDO technology*

*Blown film line  
with MDO from  
Hosokawa Alpine,  
installed at the  
customer Grand-  
Master, Russia*



*With the further development of its proven MDO technology, Hosokawa Alpine has succeeded in taking a decisive step towards the production of sustainable packaging from blown film. One of the customers who relies on Alpine technology is the Russian film manufacturer Grand-Master. This technology paves the way for high-performance full PE films, from which the customer benefits as a pioneer in the domestic market*

Hardly any other topic has dominated science, politics and society in recent years as much as global warming. To counter it, experts worldwide see the minimisation of CO<sub>2</sub>-intensive plastics as a clear goal. Numerous well-known international brands and retailers have committed themselves to making all packaging recyclable by 2025. Thus, the development of environmentally friendly packaging materials is a current and relevant mission,

which Hosokawa Alpine has accepted. The machine manufacturer has already accumulated 25 years of experience in film stretching technology. With the further development of the proven Machine Direction Orientation (MDO) systems, a decisive step has been taken for the production of fully recyclable mono-material films – enabling the Russian film manufacturer Grand-Master to position itself as a pioneer in the domestic market.





*Film Winder by Hosokawa Alpine, installed at Grand-Master, Russia*

### Full PE films of the highest quality

MDO technology is based on mono-axial film stretching and opens up the possibility of specifically adapting and improving the properties of the end product. Various mechanical and optical properties or film thickness can be modified in this way. This is the decisive component for the production of high-performance mono-material composites made of polyethylene, which can be fully recycled after their original use and reused in the circular economy without material loss. For a long time, the necessary properties could not be achieved. "Until now, composites had to be produced from different materials in order to achieve the desired product properties. However, these are never completely recyclable or can only be recycled with difficulty. With our MDO technology, films can be produced in the required quality. This innovative technology for the production of flexible packaging is an important step towards future-proof and sustainable full PE solutions. These mono-material solutions are a global trend right now," explains Ivan Evseviev, Sales Manager at Hosokawa Micron St. Petersburg (Hosokawa Alpine's branch in Russia). This also convinced the customer Grand-Master, who is located near Moscow. The renowned manufacturer has been active on the market for over 15 years with high-quality multilayer blown films for printing and lamination, thermo-shrink film and films for the agricultural sector and has been able to establish itself firmly in the Russian premium segment. Grand-Master's machinery is now complemented by a line from Augsburg/Germany, as the topics of full PE and sustainability have been at the top of the company's agenda for some time, as Mikhail Ryazanskiy, sales manager at Grand-Master, explains: "We are firmly convinced that the future belongs to such environmentally friendly technologies. That's why we didn't hesitate to include full PE solutions in our portfolio – even though this makes us absolute pioneers in Russia. The 5-layer blown film line with MDO from Hosokawa Alpine is the best possible choice for this."

### One system, versatile possibilities

The high-tech blown film line can be operated with or without MDO, giving the customer maximum flexibility in the production of different films: one line enables the production of blocked, unblocked and unfolded MDO films. Grand-Master produces films for a wide range of applications such as twist wrap, breathable films, shrink films and full PE laminates. A special feature of the Hosokawa Alpine line is the unfolding device. The line enables Grand-Master to serve different markets and to react to market developments without major line changes. Alpine's innovative blown film technology is a basic prerequisite for the production of stretched film at the highest quality level. A net lay-flat width of 2,600 mm enables production of two panels of 1,300 mm each per winding station without MDO or two panels of 1,175 mm each with Alpine MDO. For optimising the stretched full PE films, the machine is equipped with Hosokawa Alpine's TRIO technology ("Trim Reduction for Inline Orientation"). This significantly improves the flatness and the MDO film is optimally prepared for lamination or printing. TRIO also ensures significant material savings in edge trim waste and thus maximises economic efficiency. In addition, there is a flexible gap adjustment in the MDO. This enables flexible adjustment of the stretch nip to the respective application, thereby significantly reducing the neck-in and thus the use of resources. The customer Grand-Master is satisfied with the result, as Mikhail Ryazanskiy explains: "With the MDO line from Hosokawa Alpine, we can not only produce materials that are currently in demand, but we are also equipped for the sustainable full PE packaging of tomorrow."

**HOSOKAWA ALPINE** Aktiengesellschaft  
Peter-Doerfler-Str. 13-25, 86199 Augsburg, Germany  
[www.hosokawa-alpine.com](http://www.hosokawa-alpine.com)

# Preconfigured Feeders Offer Plastics Industry a Powerful and Efficient Feeding Solution



*ProRate PLUS continuous single screw gravimetric feeders are ideal for the feeding of pellets, granules and other free-flowing bulk materials in secondary plastics applications  
(Images: Coperion K-Tron, Niederlenz, Switzerland)*

*Coperion K-Tron announce the expansion of the original ProRate™ feeder portfolio with a completely new and cost-effective feeder line called ProRate PLUS. Answering the call from the marketplace for a robust and reliable feeder for simple feeding applications in the plastics industry, Coperion K-Tron developed a completely new feeder line built on 100 years of feeding experience. The ProRate PLUS continuous gravimetric feeder line is an economical solution and offers a quick return on investment due to its good price-performance ratio and fast delivery times. It was designed with the specific requirements of the plastics processing industry in mind*

These single screw feeders are ideal for the feeding of pellets, granules and other free-flowing bulk materials in secondary plastics applications. ProRate PLUS feeders are available in three sizes and can be installed as

individual units or easily arranged in cluster of up to six feeders around a process inlet, depending on the recipe formulation. The ProRate PLUS feeder line features a unique design which allows a

very compact, space-saving arrangement. The trapezoidal shape of the ProRate Plus feeders allows up to six feeders to be easily grouped around an extruder inlet within a 1.5 m [5 ft] radius. The three feeder models

PLUS-S, PLUS-M and PLUS-L cover a wide range of throughputs. The ProRate PLUS feeders are capable of handling feed rates from 3.3 up to 4800 dm<sup>3</sup>/h [0.12 up to 400 ft<sup>3</sup>/h], depending on the material. Theoretically a feeding system with six ProRate PLUS-L feeders can feed up to 28.8 m<sup>3</sup>/h [1017 ft<sup>3</sup>/h] on a footprint of only 7 m<sup>2</sup> [75 ft<sup>2</sup>].

ProRate feeders are highly standardized and include a variety of design features to optimize performance and ease of use. Simple access for cleaning and maintenance, even within a cluster, is provided thanks to a patent-pending rail system called "ProClean Rail". ProClean Rail makes it possible to retract the base unit toward the rear of the feeder and rotate it for access to the feeding section and screw element. This allows for maintenance and cleaning of the feeding unit while keeping the feeder in position. In addition, the bellows and screw use the latest magnet technology for simple but robust mounting. The magnet connections allow these parts to be released without tools while at the same time providing the required

holding force for optimal and safe operation. Thanks to the high level of standardization of the feeders, the number of spare parts required for emergency stock is minimal. Many parts are identical for all three models and can be used as exchange parts for all devices. ProRate PLUS feeders are suitable for use in hazardous locations rated NEC Class II, Div. 2, Group F & G and ATEX 3D/3D (outside/inside).

#### Accurate weight measurement and reliable control modules for efficient operation

All ProRate PLUS feeders are equipped with P-SFT load cells, featuring reliable Smart Force Transducer weighing technology. They operate under compression and provide accurate, stable and reliable digital weight measurement under a broad range of operating conditions. The load cells supply a direct digital weighing signal and the onboard microcontroller ensures excellent repeatability and stability. P-SFT load cells have a high tolerance to vibration and electrical noise. They feature built-in over and underload protection.

Each feeder comes equipped with its own pre-wired ProRate PLUS PCM control module. The PCM is mounted to the feeder stand, with adjustable height positioning. Each PCM is pre-tested in Coperion K-Tron's manufacturing facility prior to shipping. There are two models of PCM to choose from: a basic motor control unit (PCM-MD) or an advanced version with integrated user interface and line control functionality (PCM-KD). Within a group of up to eight feeders, one feeder must be equipped with the PCM-KD while the PCM-MD is sufficient for the others.

The PCM-KD comes with all the software the ProRate PLUS feeder will need for continuous applications and supports all three feeder models. Connection between weigh feeders, operator interface and smart I/O is via an industrial network. All motor setup, diagnostics and operator interface functions are integrated into the PCM-KD user interface. The PCM-KD is equipped with a host communication port (Ethernet IP or Profinet).

#### A variety of service offerings to keep processes running smoothly

Coperion K-Tron's dedication to customer satisfaction has also led to the creation of a unique new portfolio of service offerings for the launch of this product line. A variety of Start-up and Service Packages are available for ProRate PLUS feeders to ensure each customer can get exactly the level of service they need. Coperion K-Tron also offers quick and easy remote services for ProRate PLUS. From an online portal to 24-hour phone support and even remote start-up assistance, trained service technicians are available to keep systems running around the globe.

In all, the new ProRate PLUS feeder line offers a simple, robust and reliable solution for feeding a variety of free-flowing bulk materials in plastics processing applications.

*ProRate PLUS feeders can be installed as individual units or easily arranged in cluster of up to six feeders around a process inlet, depending on the recipe formulation*

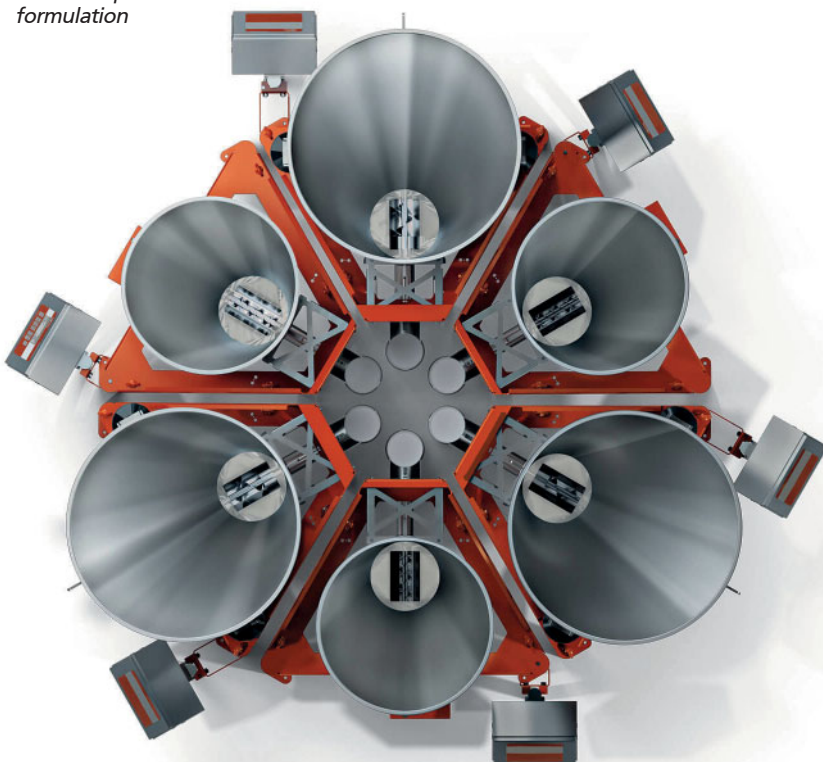

# Extrusion Lines for Natural Fibre Waste Strengthened



*Sustainability is now a key concept that affects all economic sectors, first and foremost construction, where attention is increasingly required when dealing with innovative and eco-sustainable materials, also for interior furnishings. In this respect, Bausano – leading international player in the design and production of custom extrusion lines for the transformation of plastic materials – responds to the new needs of the sector, enhancing its extrusion lines for plastic waste (PVC, PE or PP) and natural fibres, including wood dust and substances of plant origin, such as rice husks, coffee grounds, banana peels, seaweed, almond shells, avocado kernels, cork and other plant residues*

In detail, the market for composites obtained from natural fibres is experiencing significant growth thanks to the properties that make these materials unique in terms of versatility, reliability and environmental impact. In fact, they are 100% recyclable and can be transformed into a new product at low cost. By virtue of their exceptional performance characteristics, in terms of high resistance to corrosion, atmospheric agents, UV rays and impermeability, they are ideal for cladding, furniture and indoor and outdoor flooring, especially decking. Furthermore, thanks to their increased lifespan, plant fibre-plastic composite materials are also increasingly used in the automotive sector, for the internal lining of door panels, dashboards, trunks and for the production of particularly light components, which contribute to reduce the weight of vehicles.

Bausano's extrusion technology has been perfected to incorporate up to 100 phr of wood or natural fibre. The specific counter-rotating twin-screw configuration makes it possible to achieve an accurate mixing between melted polymer and fibre, passing it through the mould without the need for a melting pump. Specifically, profiles can be directly extruded from the raw material (direct extrusion) or the material can be processed starting from the granule (indirect extrusion). In direct extrusion, Bausano machines ensure the processing of fibres with a humidity level of up to 12% at a speed three times higher with respect to other solutions on the market. The granulation lines, specifically designed to ensure maximum performance at any production speed, also enable the use of recycling materials and



can be configured with premixing or gravimetric dosing systems upstream. The granules obtained can thus be transformed into a finished product either through moulding or extrusion, with twin or single screw. Lastly, the lines are distinguished by the high degree of customisation, the wide range of modular accessories and a special coating, on request, which extends the useful lifespan of screws and cylinders up to 25,000 hours, before replacement is required.

Clemente Bausano, Vice President of the Company states: "The plant fibre-plastic composite materials are a valid alternative in construction and architecture. In fact, they are part of a circular economy perspective: for example, the wood used is usually a product of waste from the furniture industry that is recycled to be extruded again, thus limiting deforestation. Europe is currently the third largest market in the world for wood-plastic composites and I believe that EU policies for the environment and climate provide significant opportunities for the growth of the sector, in particular through the "Renovation Wave" strategy, an integral part of the Green Deal promoted by Brussels". And he concludes: "For Bausano, enhancing this range of extruders is part of a broader programme, aimed at pursuing the sustainable development goals drafted in the United Nations 2030 Agenda. A path that sees us engaged on three levels: social, environmental and economic, acting as the spokespeople for a virtuous change that also involves our customers".

# Cross-Linked Foam Boards Produced on ZE BluePower Extruder

*ZE 42 Blue Power twin-screw extruder optimally adapted to the process keeps crosslinking in the extruder under control*

*In its capacity as one of six associated partners, KraussMaffei has promoted a joint cooperation project funded by the German Federal Ministry for Economic Affairs and Energy (BMWi). The common aim of the project partners was to develop a closed value-added chain for thermoset rigid phenolic foam – starting from the production, through planning, construction and operation up to material recycling. The highly innovative rigid foam products are ideal for the use as load-bearing insulating composite components in the building sector, e. g. for mounting solar modules or air-conditioning systems on roofs or for the installation of windows, railings or awnings to the building façade*

## **KraussMaffei promotes research project**

Within the frame of this project, KraussMaffei's extrusion division actually succeeded in matching the phenolic compound formulation and the process control in order to be able to extrude boards with low density, high mechanical stability, low thermal conductivity and good fire resistance on a co-rotating twin-screw extruder. "The excellent fire properties of the new thermoset foam boards are indeed something very special," declares Andreas Madle, process engineer in the Process-Engineering Development Division and project manager at KraussMaf-



fei. Even without the addition of flame retardants, the new material is extremely flame resistant and hence classified as fire protection class B1.

## **Optimally configured twin-screw extruder keeps cross-linkage under control**

The ZE 42 BluePower twin-screw extruder available in KraussMaffei's R&D center in Hannover was used for the production of the foam boards with a thickness of 50 mm. In terms of process-engineering characteristics, this extruder was precisely adapted to the requirements of the material processed. "The challenge was to keep the cross-linking process in the extruder under control and to avoid the formation of dead spots," says Andreas Madle. This goal has been achieved through a low-shear screw geometry, moderate processing temperatures ranging between 100 and 120°C and the selection of a screw tip that is characterized by an extremely reduced free volume. The final product is a thermoset foam with a density of about 800 kg/m<sup>3</sup> and a good thermal conductivity of 0.12 W/mK. "We are well aware of the fact that our foam is rather heavy compared to thermoplastic foam such as EPS, which can reach densities of less than 30 kg/m<sup>3</sup>," states Andreas Madle and adds: "However, these two foam products are not really comparable as their fields of application are completely different. In fact, the new foam is intended, among others, as an insulating material for loaded applications and the higher mechanical stability involved inevitably requires a higher density." Furthermore, the process engineer is convinced that future research and development projects will allow the density of phenolic resin foam to be further reduced. The other cooperation partners involved in this project were Hexion GmbH (phenolic resins), Ejot Baubefestigung GmbH (fastening solutions for the building industry), Schöck Bauteile GmbH (load-bearing insulating components) as well as Robert Bosch GmbH (various products and consumer goods). The project has been coordinated by Chemnitz Technical University, Faculty of Mechanical Engineering, Chair in Plastics.

*Energy-efficient phenolic rigid foam panels feature low density with high mechanical stability, low thermal conductivity and good fire properties*



*Phenolic resin panels are particularly suitable for the stable fastening of photovoltaic systems*



**KraussMaffei Extrusion GmbH**  
An der Breiten Wiese 3-5, 30625 Hannover, Germany  
[www.kraussmaffei.com](http://www.kraussmaffei.com)

# EXTRUSION

EXPERT MAGAZINE ON PLASTICS EXTRUSION

The only technical magazine worldwide exclusively for the sectors:

- Material Preparation
- Compounding
- Extrusion
- Recycling
- Calendering
- Thermoforming
- Welding
- Finishing of Plastics and Elastomers



**Extrusion** (German)

**Extrusion International** (English)

**Extrusion International USA** (English)

**Extrusion Russia Edition** (Russian)

**Extrusion Asia Edition** (Mandarin/English)

The only plastics trade magazine for Asia, published from Germany

8 issues a year

6 issues a year

6 issues a year

4 issues a year

2 issues a year

**SMART  
EXTRUSION**

All editions available for free:  
[www.smart-extrusion.com](http://www.smart-extrusion.com)

**VVA** Verlag GmbH Cologne/Germany



# CPS+ eMarketplace

*Specialized* online sourcing & business matching platform serving global buyers looking for *Plastics and Rubber* technologies

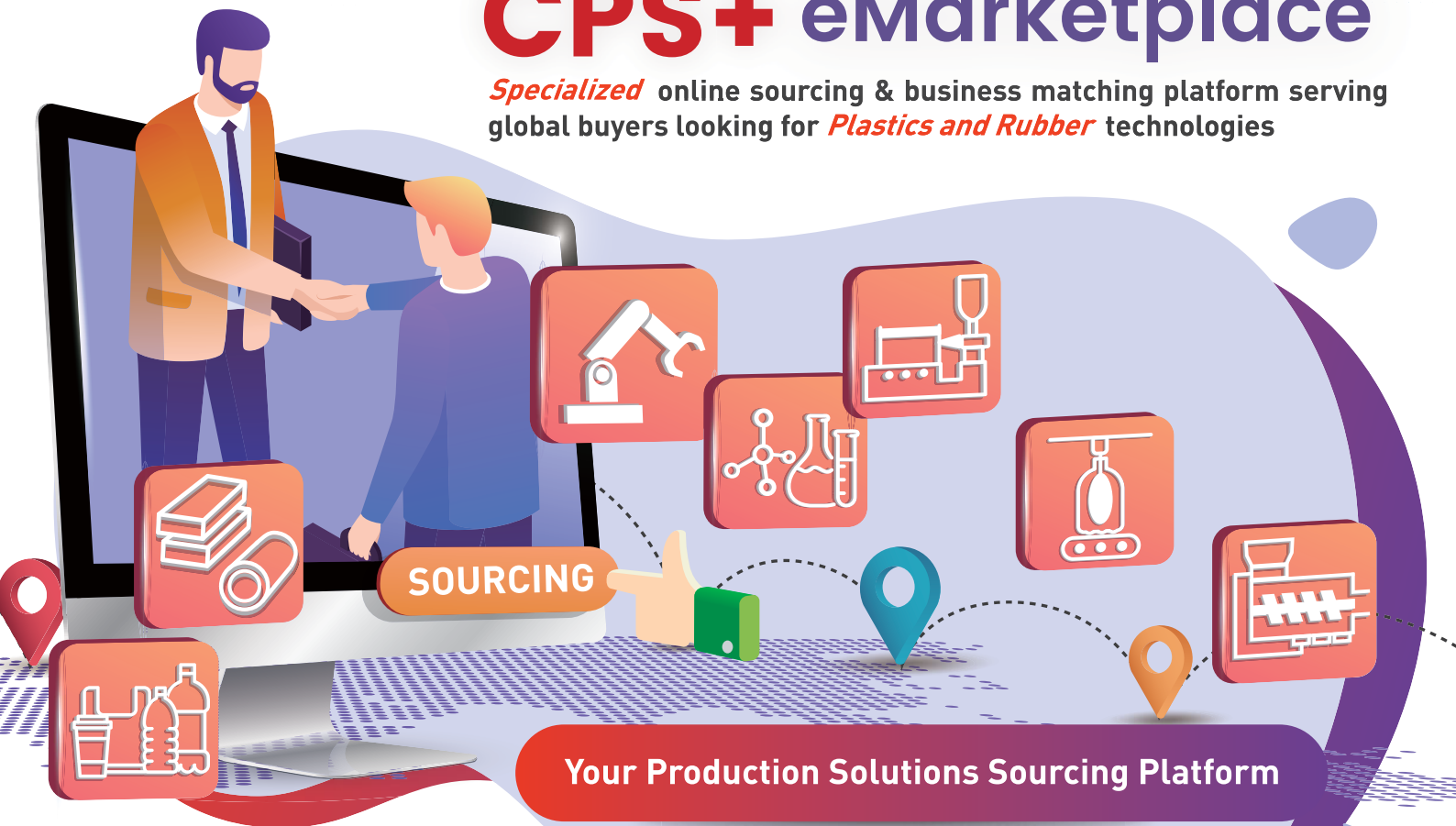

Your Production Solutions Sourcing Platform

Powered by  **Chinaplas**<sup>®</sup>  
国际橡塑展

- Supported by world's leading plastics and rubber exhibition with 35+ years of history
- Managed by professional team which knows the market, suppliers and buyers

## Encompasses Full Spectrum of Products by 4,000+ Technology Makers

- Where you find the latest, the hottest and full variety of plastic and rubber materials, machinery and production solutions, semi-finished products and services by worldwide suppliers

## Connects with Suppliers Anytime

- View product videos and photos, get price quotation, send direct message or live chat with suppliers whenever needed

## Offers Precise & Quality Matching Service

- Intelligent functions as well as designated personnel to help buyers find the best-suited suppliers and products



[www.ChinaplasOnline.com/eMarketplace](http://www.ChinaplasOnline.com/eMarketplace)

Submit Your Sourcing Requests to us  
NOW for the Best Matching!

